

EN

COMPATIBILITY GUIDE

ENGINEERING IMMERSIVE EXPERIENCES



QS BT1

QS 210

QS 220

1. INTRODUCTION

Depending on the system revision, Motion Lock connections between the sets may vary and may need conversion kits. There are the following main revision groups:

Type A	Type B	Type C
QS-220 R2.5.x	QS-220 R2.6.x	QS-220 R3.0.x
-	QS-220 R2.7.x	QS-210 All revisions
-	QS-220 R2.8.x	QS-BT1 All revisions

Systems within each revision group are 100% compatible and don't require any additional cables. However if you need to connect together systems that belong to different groups, make sure to get correct wire harnesses first.

System revision can be found on the rating plate located on the QS-SB2 power cabinet under main power switch :

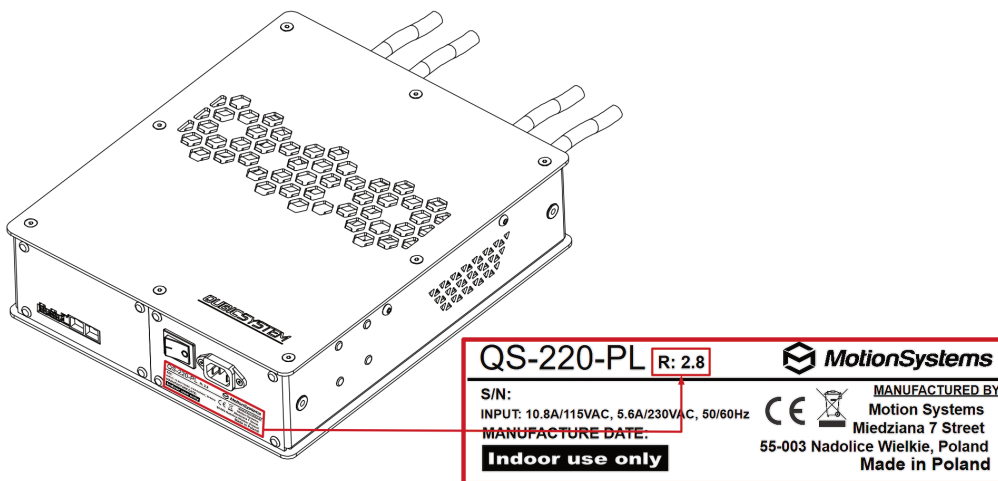

General guidelines are as follows:

1. If different revisions of QS-SB2 are connected together, then only order of the Motion Lock cables connection matters.
2. Start connecting conversion kit by plugging in the Motion Lock switch first.
3. Always connect Motion Lock switch to the power cabinet with the highest revision.
4. Connection order of M-BUS cables does not matter. You can connect M10 controller to the power cabinet of your choice.
5. Remember to keep the CFG switches setting according to appropriate layout.

2. QS-210/220

2.1. CONNECTING "C" WITH "B"

Required adapters:

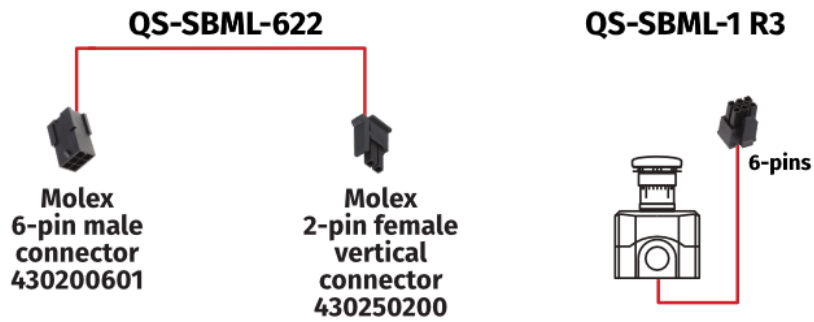

Motion Lock connection diagram:

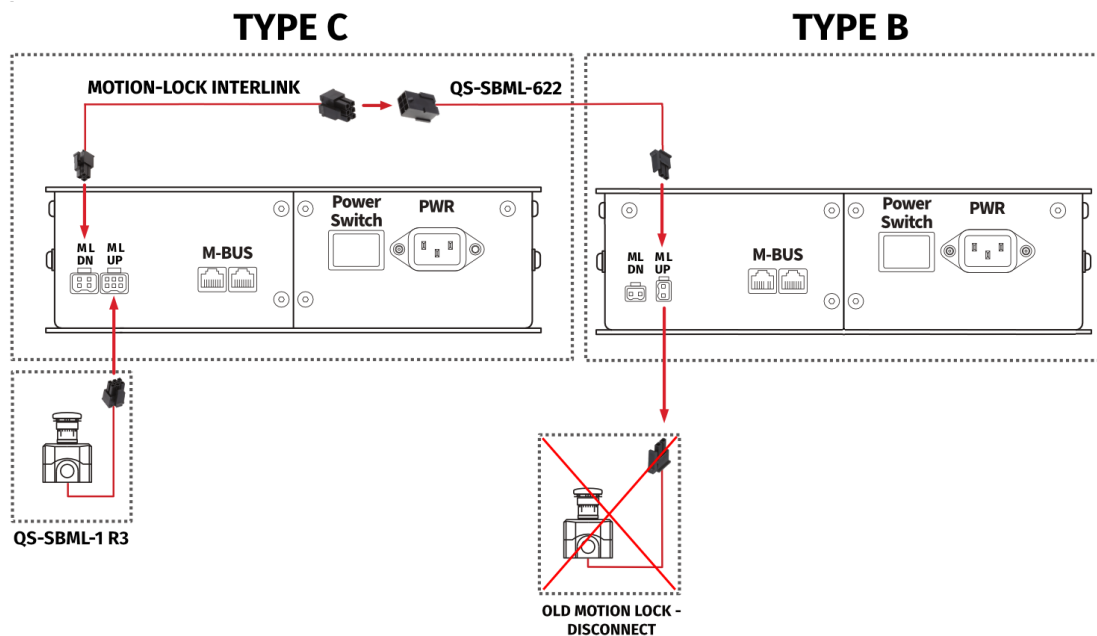

Steps:

1. Disconnect old **2-pin Motion Lock switch**, it won't be needed anymore.
2. Connect new **6 pins QS-SBML-1 R3 Motion Lock switch** into the **ML UP** port in the **Type C** power cabinet.
3. If you have second **Type C** power cabinet, then connect it to the first **Type C** using its standard wire harness - refer to the interconnections scheme in the original user manual.
4. Connect one end (4-pins) of **Motion Lock INTERLINK** cable to the **ML DOWN** port in the **Type C** power cabinet.
5. Connect another end (6-pins) of **Motion Lock INTERLINK** cable to **QS-SBML-622** adapter.
6. Connect another end (2-pins) of **QS-SBML-622** adapter to **ML UP** port in the **Type B** power cabinet.
7. If you have yet another **Type B** power cabinet (2 in total), then connect it to **Type B** using its standard wire harness - refer to the interconnections scheme in the original user manual.
8. Connect **M-BUS cables** and **M10** in the order of your selection - it does not matter where the bus start and ends.
9. Plug **M-BUS terminator** into **empty M-BUS port**.
10. Plug in the power cables with adequate plugs into power sockets.
11. Set the appropriate position on the **CFG switch** according to the actuators layout of your choice (more information about CFG switch position and layout selection can be found in the original user manual).

2.2. CONNECTING "C" WITH "A"

Required adapters:

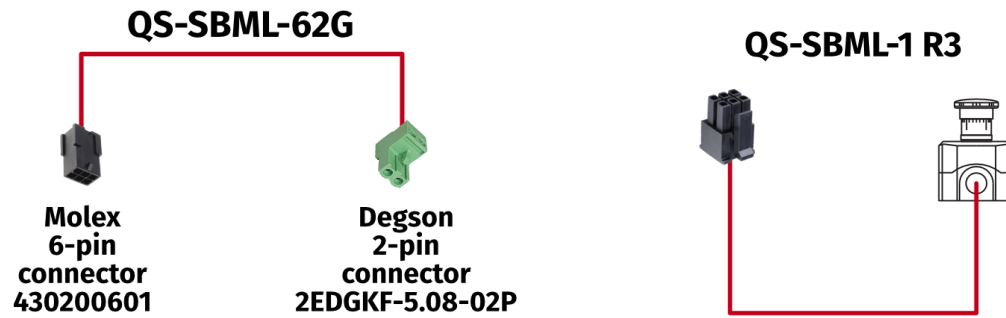

Motion Lock connection diagram:

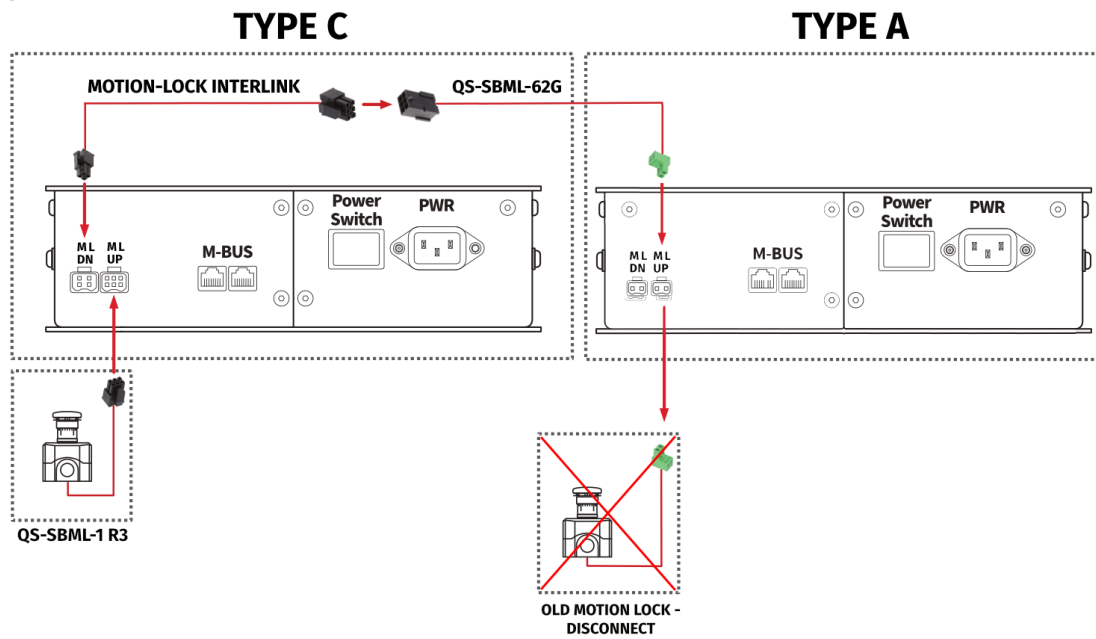

Steps:

1. Disconnect old **2-pin Motion Lock switch**, it won't be needed anymore.
2. Connect new **6 pins QS-SBML-1 R3 Motion Lock switch** into the **ML UP** port in the **Type C** power cabinet.
3. If you have second **Type C** power cabinet, then connect it to the first **Type C** using its standard wire harness - refer to the interconnections scheme in the original user manual.
4. Connect one end (4-pins) of **Motion Lock INTERLINK** cable to the **ML DOWN** port in the **Type C** power cabinet.
5. Connect another end (6-pins) of **Motion Lock INTERLINK** cable to **QS-SBML-62G** adapter.
6. Connect another end (2-pins) of **QS-SBML-62G** adapter to **ML UP** port in the **Type A** power cabinet.
7. If you have yet another **Type A** power cabinet (2 in total), then connect it to **Type A** using its standard harness - refer to the interconnections scheme in the original user manual.
8. Connect **M-BUS cables** and **M10** in the order of your selection - it does not matter where the bus start and ends.
9. Plug **M-BUS terminator** into **empty M-BUS port**.
10. Plug in the power cables with adequate plugs into power sockets.
11. Set the appropriate position on the **CFG switch** according to the actuators layout of your choice (more information about CFG switch position and layout selection can be found in the original user manual).

2.3. CONNECTING "A" WITH "B"

Required adapters:

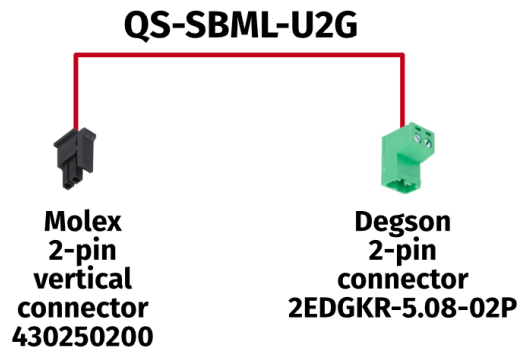

Motion Lock connection diagram:

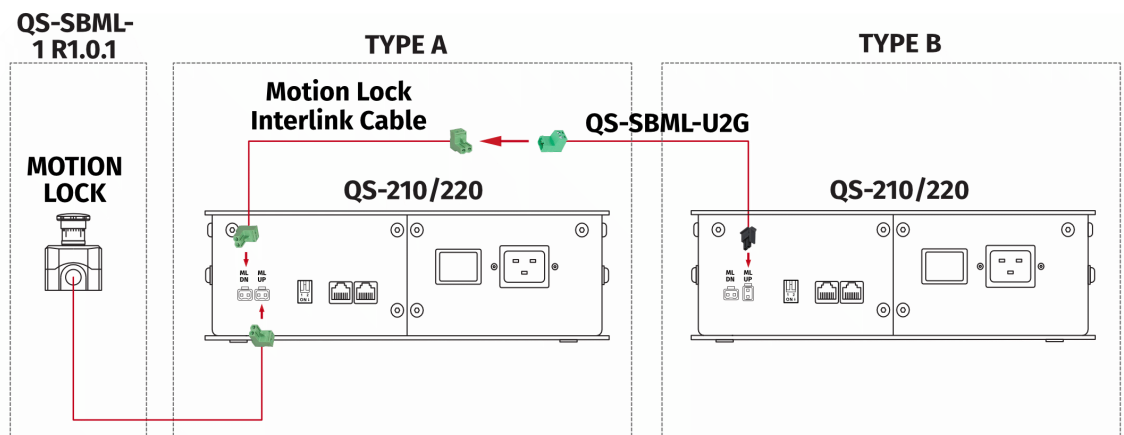

Steps:

1. Connect **2 pin Motion Lock switch** into the **ML UP** port in the **Type A** power cabinet per original user manual.
2. If you have second **Type A** power cabinet, then connect it to the first **Type A** using its standard wire harness - refer to the interconnections scheme in the original user manual.
3. Connect one of **Motion Lock Interlink Cable** to the **ML DN** port in the **last Type A** power cabinet.
4. Connect another end of **Motion Lock Interlink Cable** to the matching **QS-SBML-U2G** adapter plug.
5. Connect another end (2-pin black) of **QS-SBML-U2G** adapter to **ML UP** port in the Type B power cabinet.
6. If you have another **Type B** power cabinet (2 in total), then connect it to **Type B** using its standard harness - refer to the interconnections scheme in the original user manual.
7. Connect **M-BUS cables** and **M10** in the order of your selection - it does not matter where the bus start and ends.
8. Plug **M-BUS terminator** into **empty M-BUS port**.
9. Plug in the power cables with adequate plugs into power sockets.
10. Set the appropriate position on the **CFG switch** according to the actuators layout of your choice (more information about CFG switch position and layout selection can be found in the original user manual).

3. QS-BT1 AND QS-210/220

Every QS-BT1 unit is Type C Motion Lock from factory (Motion Lock button not included and can be purchased separately from our retailers; Motion Lock interlink cable is included).

3.1. CONNECTING "C" WITH "B"

Required adapters:

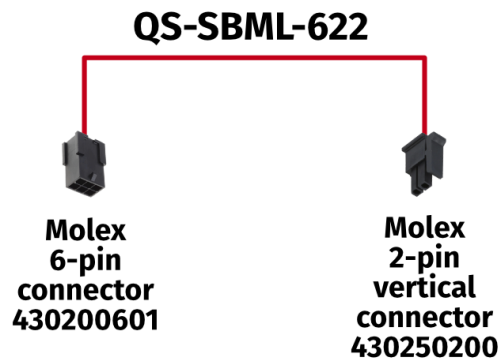

Motion Lock connection diagram:

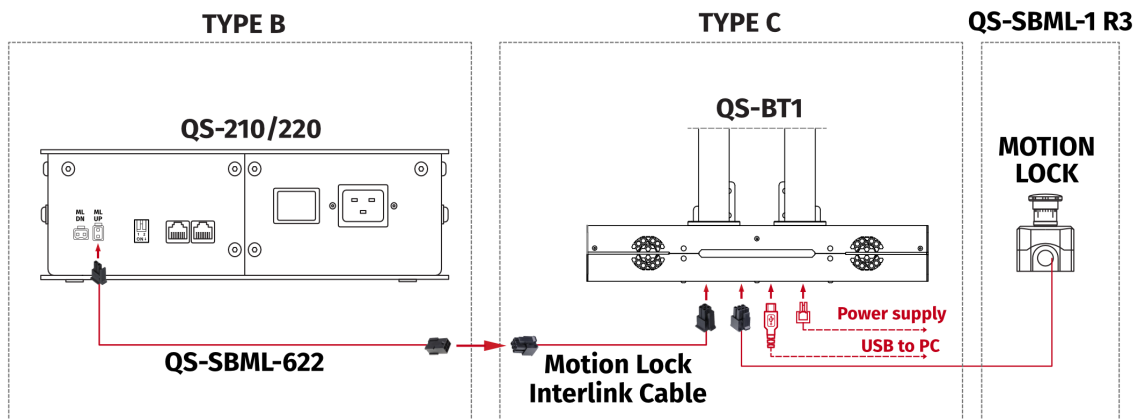

Steps:

1. Connect **6 pins QS-SBML-1 R3 Motion Lock button** into the matching **6-pin** port in the QS-BT1.
2. Connect one end (4-pins) of **Motion Lock INTERLINK** cable to the matching **4-pin** port in the QS-BT1.
3. Connect another end (6-pins) of **Motion Lock INTERLINK** cable to 6-pin connector of **QS-SBML-622** adapter.
4. Connect the connector (2-pins) of **QS-SBML-622** adapter to **ML UP** port in the **Type B** power cabinet.
5. If you have another **Type B** power cabinet (2 in total), then connect it to **Type B** using its standard wire harness - refer to the interconnections scheme in the original user manual.
6. Connect **M-BUS cables** and **M10** to your power cabinets in the order of your selection - it does not matter where the bus start and ends. QS-BT1 works separately via USB cable.
7. Plug **M-BUS terminator** into **empty M-BUS port** in power cabinet.
8. Plug in the power cables with adequate plugs into power sockets.
9. Set the appropriate position on the **CFG switch** of power cabinet according to the actuators layout of your choice (more information about CFG switch position and layout selection can be found in the original user manual).

3.2. CONNECTING "C" WITH "A"

Required adapters:

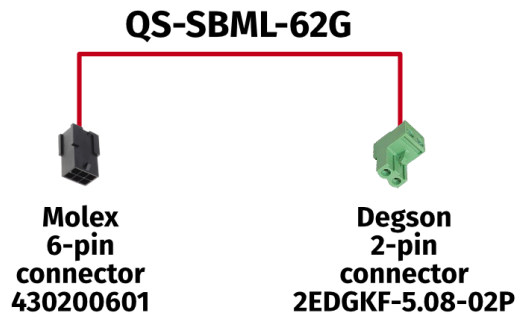

Motion Lock connection diagram:

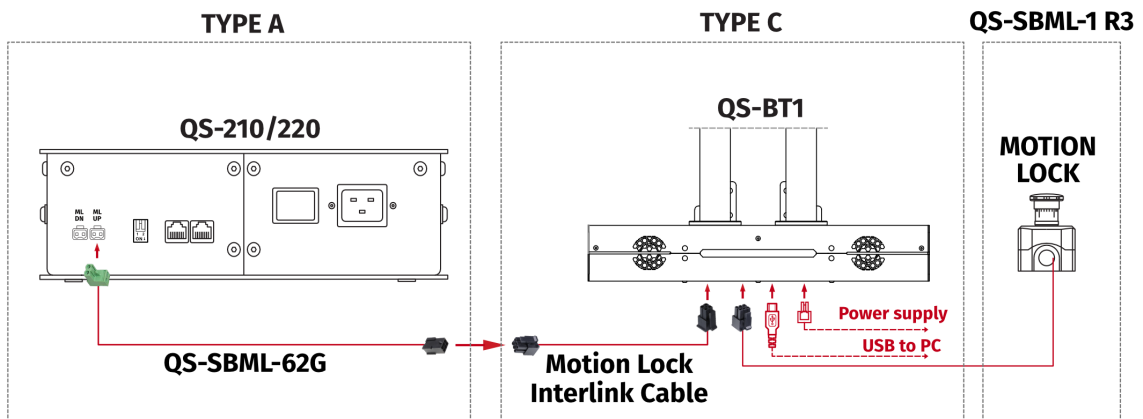

Steps:

1. Connect **6 pins QS-SBML-1 R3 Motion Lock button** into the **ML UP** port in the QS-BT1.
2. Connect one end (4-pins) of **Motion Lock INTERLINK** cable to the **ML DOWN** port in the QS-BT1.
3. Connect another end (6-pins) of **Motion Lock INTERLINK** cable to 6-pin connector of **QS-SBML-62G** adapter.
4. Connect the green connector (2-pins) of **QS-SBML-62G** adapter to **ML UP** port in the **Type A** power cabinet.
5. If you have another **Type A** power cabinet (2 in total), then connect it to **Type A** using its standard wire harness - refer to the interconnections scheme in the original user manual.
6. Connect **M-BUS cables** and **M10** to your power cabinets in the order of your selection - it does not matter where the bus start and ends. QS-BT1 works separately via USB cable.
7. Plug **M-BUS terminator** into **empty M-BUS port** in power cabinet.
8. Plug in the power cables with adequate plugs into power sockets.
9. Set the appropriate position on the **CFG switch** of power cabinet according to the actuators layout of your choice (more information about CFG switch position and layout selection can be found in the original user manual).

4. DIP SWITCHES CONFIGURATION

Conversion between Type A, B and C does NOT affect DIP switches configuration and layouts in anyway. Refer to original QS-210, QS-220, QS-CH2, QS-V20 and QS-S25 user manuals to see how to configure **DIP switches and layouts** for your setup.

INFO

For applications that utilize QS-CH2:

- When 1x QS-210 or 1x QS-220 is installed in the cockpit which is then installed on top of the QS-CH2, then the DIP switch in QS-CH2 must be configured to **Actuator 3-4**.
- When 2x QS-210 or 2x QS-220 (typical scenario) are installed in the cockpit which is then installed on top of the QS-CH2, then the DIP switch in QS-CH2 must be configured to **Actuator 5-6**.



Q5 BT1

Q5 210

Q5 220