

QS-220

User Manual

R3

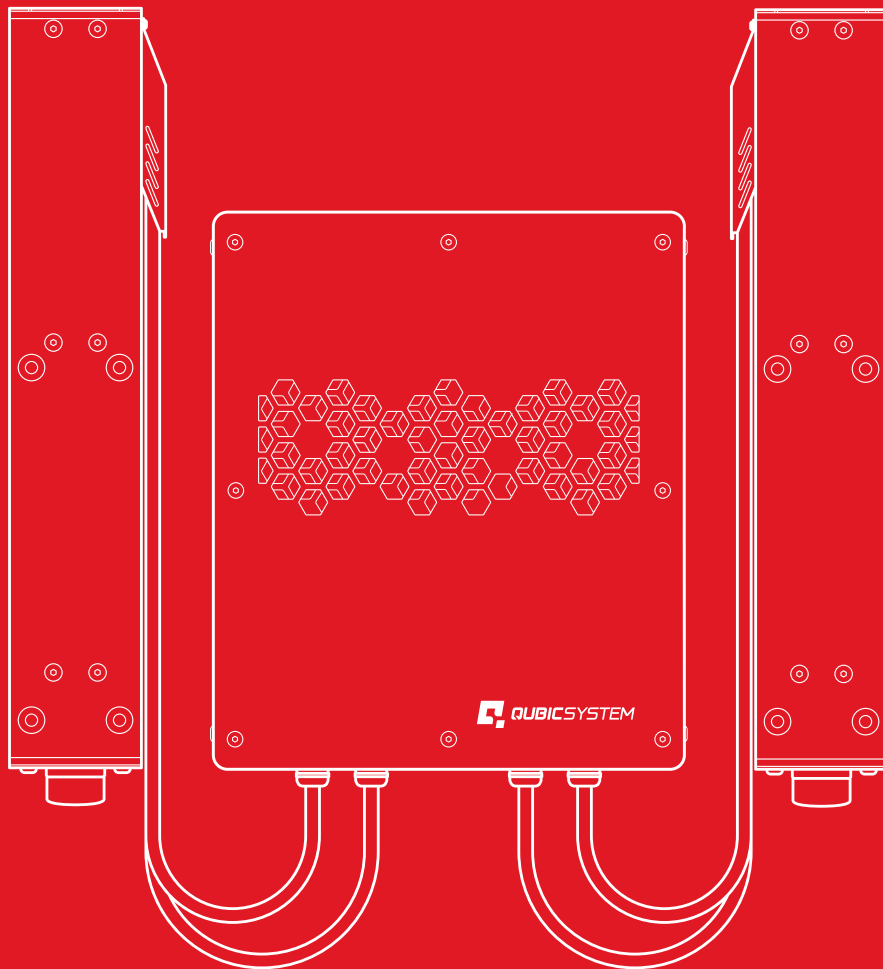

QUBICSYSTEM

The Motion Systems, manufacturer of Qubic System, would like to thank you for choosing the QS-220, an innovative product that helps you develop highly reliable training and entertainment solutions that reproduce key immersive elements, such as surface textures, acceleration, engine vibrations and vehicle dynamics for multiple types of land, air or sea vehicles. Our motion system has been designed to deliver the most realistic simulation experience. We hope you enjoy your new Qubic System!

Join our sim racing channel at the Qubic System YouTube

<https://www.youtube.com/c/QubicSystem>



NEWS & EVENTS

The latest news from the simulation world.
QubicSystem.com/News



CHECK OUR SOCIAL MEDIA

Everything you wish to know is here!
facebook.com/qubicsystem



SUPPORTED GAMES

Racing games and professional simulation software.
QubicSystem.com/Supported-Games

Contents

1	Safety precautions	6
1.1	Essential Information	6
1.2	Health and Safety Instruction	8
2	Product description	11
2.1	Intro Set	12
2.2	Extension set	14
2.3	Dimensions	15
2.4	Grounding requirements	16
2.5	Power requirements	17
2.6	Environmental conditions	18
3	Setup and installation	19
3.1	Before QS-220 Installation	19
3.2	Connecting QS-220 to cockpit	21
3.3	Actuators layout	22
3.4	Intro set layouts	23
3.5	Intro set cable connections	24
3.6	Extension set layout setup	26
3.7	Extension set layouts	27
3.8	Extension set cable connections	29
3.9	Extension set - connecting with traction loss system	31
3.10	Software Installation	33
4	Maintenance and Cleaning	39
5	Troubleshooting	40
5.1	Creating a snapshot	42
5.2	Discord channel	45
6	Advanced applications	46
6.1	Adding additional devices to the motion lock circuit	46
6.2	Implementing the working zone protection	48
6.3	Increasing safety level	49
6.3.1	Assembling Motion Lock jumper	49
6.3.2	Adding power-cut circuit with E-STOP button	50
6.3.3	Implementing the working zone protection with power-cut circuit	52
7	Environmental Impact and Disposal	53
8	Liability Disclaimer	53
9	Warranty	54
10	Copyright	55
11	Manufacturer information	55

1. SAFETY PRECAUTIONS

INFO

Read all safety instructions before installing and using this product. Save this document for future reference. If ownership of this product is transferred, be sure to include this manual.

WARNING

QS-220 is not intended for use by children under 16 years of age. Close supervision and safety instruction is required when this product is used by or near children or people with reduced physical, sensory or mental capabilities. Keep the packaging away from small children as it poses a suffocation risk.

1.1. ESSENTIAL INFORMATION

To reduce the risk of burns, fire, electrical shock, injury or mechanical damage:

WARNING



Always turn all the power switches off before plugging and unplugging the QS-220. Dangerous voltages level can be present in power cabinet for a few minutes after turning off the machine.

- Use the QS-220 only for its intended purpose, according to instructions.
- Unplug the QS-220 from the power supply if it is not used for an extended period or when there is a need to perform hardware installation, maintenance, servicing or repairs.
- Turn off the QS-220 when it is not in use.
- The QS-220 was designed for indoor use only - **DO NOT** store or use the product outdoors.
- Keep the QS-220 away from the heat sources, high humidity, water, and other liquids. **DO NOT** store in cold place where water condensation may occur.
- **DO NOT** disassemble the product. Any tampering with or altering the product will void the warranty, poses a serious risk of electric shock, and may irreparably damage the product.
- **DO NOT** cover the ventilation holes in the QS-SB2 power cabinet.
- Keep the power cord plug and the socket dry, clean and dust-free.
- Protect the power cord from damage caused by being stepped on, rubbed against, or pinched.

- **DO NOT** use the QS-220 if the ambient temperature is below 4° Celsius (39° Fahrenheit) or above 45° Celsius (113° Fahrenheit).
- **DO NOT** use the QS-220 if it has been damaged, or any component is broken or missing. Please contact technical support.
- **DO NOT** use attachments or replacement parts not recommended or approved by the manufacturer. If you must to replace the power cord use only certified one with the same rating as replaced one.
- Connect the QS-220 to a properly grounded outlet only. See grounding instructions in section 2.4 on page 16.
- If you want to increase safety level of the system, you can add external safety devices. For detailed information check section 6 on page 46.

WARNING

Stop using the QS-220 immediately and contact technical support when the machine starts to emit unusual noise, smoke or any other suspicious behaviour indicating the machine is not working properly.

1.2. HEALTH AND SAFETY INSTRUCTION

The safety of Qubic System users is the top priority. To protect users and bystanders against injuries caused by mechanical parts movement and electrical connectivity, the following instructions must be strictly performed.

WARNING

As with any mechanical device, the user is responsible for inspecting the condition of the machine prior to use and adhering to safe operating procedures.

What must be done before turning on the machine:

- Check if nothing is blocking machine movements or air vents. The minimum distance between the air vents in the power cabinets and any outside parts of the cockpit equipment is 10 cm or 4 in.

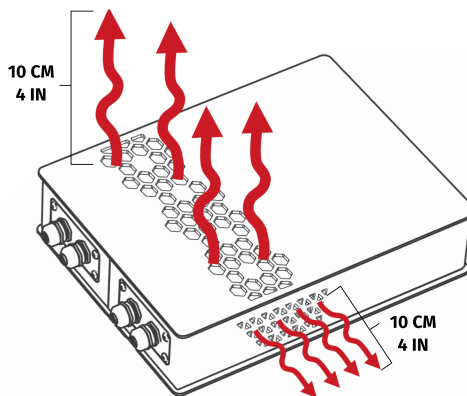

- Check if cables are mounted properly – they are not stretched or loosely connected to the socket and placed out of the moving range of the system components.
- Check that all elements are properly fixed.
- Check if there are no sharp edges nearby.

WARNING



Dangerous voltage level may occur in the QS-SB2 power cabinet and cables during the operation and for a few minutes after turning off the machine.

How to turn on safely and use the QS-220:

- Check if everyone around is aware of machine rapid movements.
- Make sure that no one stands in the range of motion (minimum 1.5 m).
- Kids should be kept away from the machine.
- Pets should be kept away from the machine.
- When the QS-220 is turned on, it performs start-up calibration.

WARNING

QS-220-PL will move automatically after turning it on in order to perform start up procedure. Please be away of that movement and do not try to interrupt it.

- **DO NOT** interrupt or change the weight of payload mounted to the QS-220 during start-up calibration.
- Motion Lock Switch should be mounted close to the operator of the machine – it has to be easily reachable in every situation.
- Check Motion Lock Switch **AT LEAST** once a month to reduce the possibility of unknown failure – more information available in chapter 4 on page 39.
- Before getting on or off the machine activate Motion Lock Switch.
- In case of game crash or freeze Motion Lock Switch must be activated before getting off the machine.

INFO

To check if the machine is in the Motion Lock mode look at the main window of the QubicManager. Status of the device is visible in the lower left corner of the window:

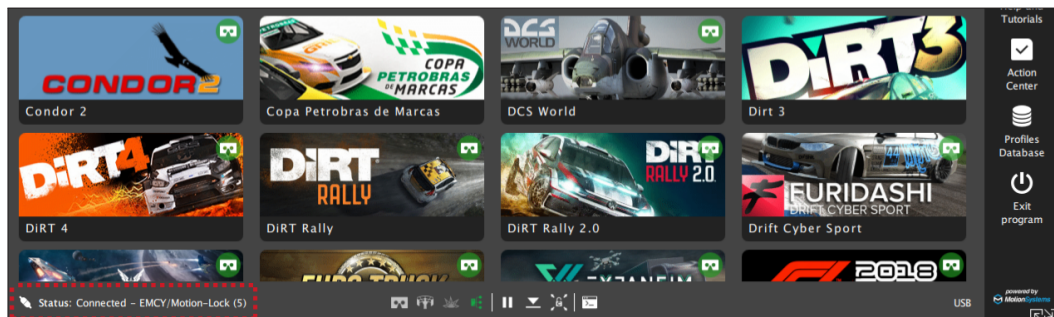

- In case of game crash the Motion Lock Switch must be pressed before getting off the machine.

WARNING

Motion Lock and Park Mode option **DOES NOT** guarantee safety. For more details see section 6.

- For VR Headset users:
 - Remove the VR goggles before entering or exiting the rig.
 - Check very carefully if cables from VR Headset are not limiting the operation range of QS-220.
 - Check if the whole VR setup is not in range of motion of the machine.
 - Check if cables are protected from being crushed by the QS-220 – **DO NOT** place them loosely under the motion rig.

INFO

Check if connected PC is capable of running the game at stable 90 frames per second or more when VR Headset is used. Lower values can cause VR sickness.

- **DO NOT** use QS-220 if you are pregnant, tired, or under the influence of alcohol or drugs.
- **STOP USING** the QS-220 immediately if pain, fatigue or any discomfort appears.
- For every two hours of playing, we recommend at least **15 MINUTES OF BREAK**.
- **DO NOT** put your hands or legs in the actuators range of motion!
- **DO NOT** use the QS-220 around small children or pets.
- **DO NOT** put any items between actuators and stabilization plates.
- **DO NOT** pull the wires connecting the actuators with the power cabinets.



2. PRODUCT DESCRIPTION

QS-220 is designed with upgradability in mind – it is possible to expand 2DOF Setup later on. Available variants are presented below.

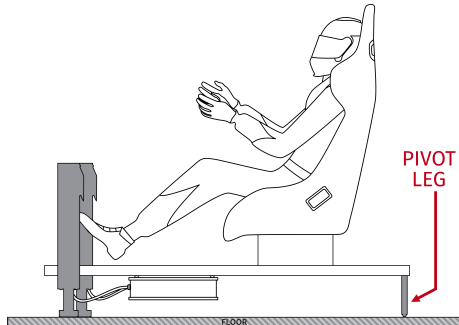

Intro set - 2DOF - Front variant

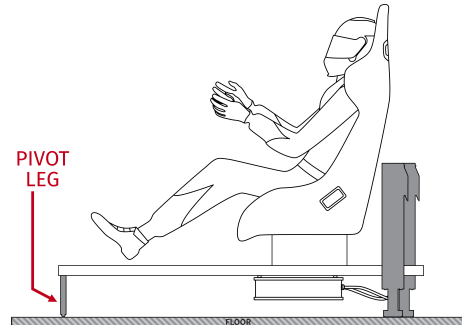

Intro set - 2DOF - Back variant

WARNING

QS-220 is delivered without the pivot leg.

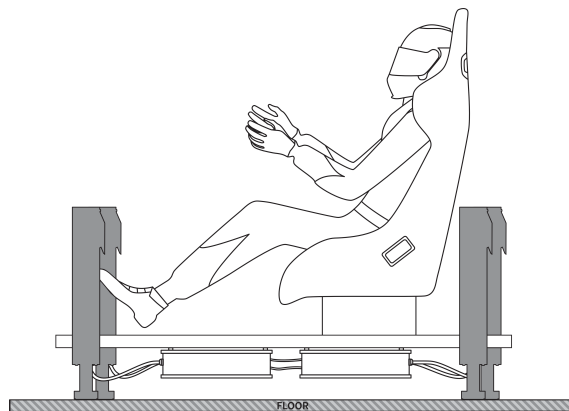

Extended set - 3DoF

2.1. INTRO SET

WARNING

Check if the package contains all listed parts. If it is incomplete, please contact the distributor/reseller.

For beginners, two actuators variant can be sufficient, Qubic System provides the option to buy Intro Set that contains QS-MC6 and QS-220 (**QS-220 is delivered without the pivot leg**).

The QS-MC6 includes following components :

- Motion Lock Switch (x 1)
- USB cable (x 1)
- M10 controller (x 1)
- BUS communication cable (x 1)
- M-BUS terminator (x 1)

M10 controller is specifically designed to use communication protocol created by Qubic System. It allows connecting PC with the QS-220, **DO NOT** try to substitute this device. M10 requires USB connection (for both cable and port in PC). M-BUS terminator, which is an RJ45 connector with the resistor. It is a small but very important part used to mark the last QS-SB2 power cabinet in the set.

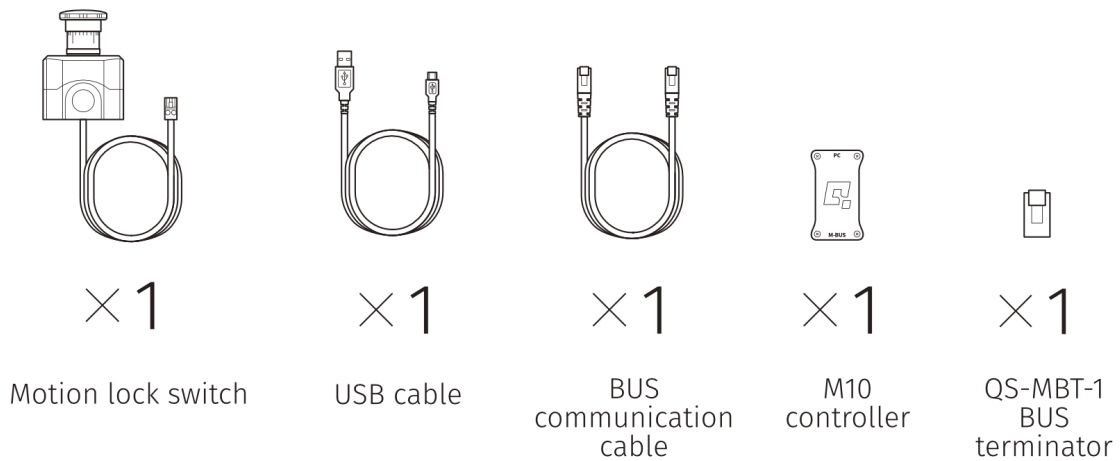

The QS-220 includes following components:

- QS-L1 actuator (x 2)
- QS-SB2 power cabinet (x 1)
- Power cord (x 1)
- BUS communication cable (x 1)
- Motion Lock interlink cable (x 1)
- Stabilization plate (x 2)
- M8x20 bolts (x 16)
- M6x12 bolts (x 8)

QS-220 is a set composed of 2 actuators (QS-L1) and power cabinet (QS-SB2).
It can be used to set up various motion rigs.

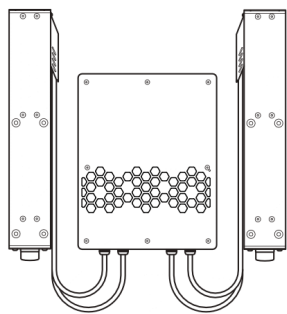

× 1

QS-L1 actuators
QS-SB2 power cabinet

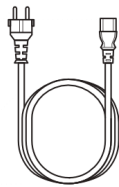

× 1

Power cord



× 1

BUS
communication
cable



× 1

Motion Lock
interlink cable



× 2

Stabilization
plate



× 16

M8 x 20



× 8

M6 x 12

2.2. EXTENSION SET

INFO

If you own Intro Set and want to expand your rig and experience by adding a second QS-220 please contact the distributor/reseller for more information.

For more demanding applications or users who want to improve their experience even further, we created an Extension Set. It is designed to be connected with Intro Set - this set does not include QS-MC6 with M10 connector as there is no need to have 2 of them in motion rig - communication between QS-SB2 power cabinets is done by connecting them directly to each other. Intro Set (QS-220) connected with Extended Set results in 3DoF configuration.

The Extension set includes following components:

- QS-L1 actuator (x 2)
- QS-SB2 power cabinet (x 1)
- Power cord (x 1)
- BUS communication cable (x 1)
- Motion Lock interlink cable (x 1)
- Stabilization plate (x 2)
- M8x20 bolts (x 16)
- M6x12 bolts (x 8)

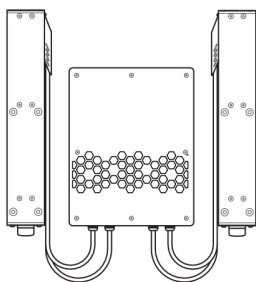

× 1

QS-L1 actuators
QS-SB2 power cabinet

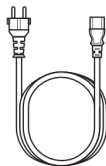

× 1

Power cord



× 1

BUS communication cable



× 1

Motion Lock interlink cable



× 2

Stabilization plate



× 16

M8 x 20



× 8

M6 x 12

2.3. DIMENSIONS

QS-SB2

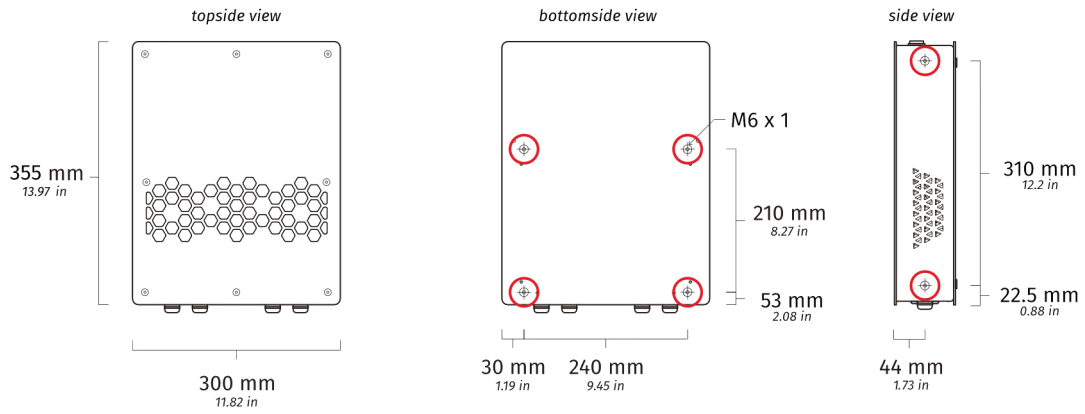

QS-SB2

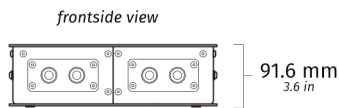

QS-L1

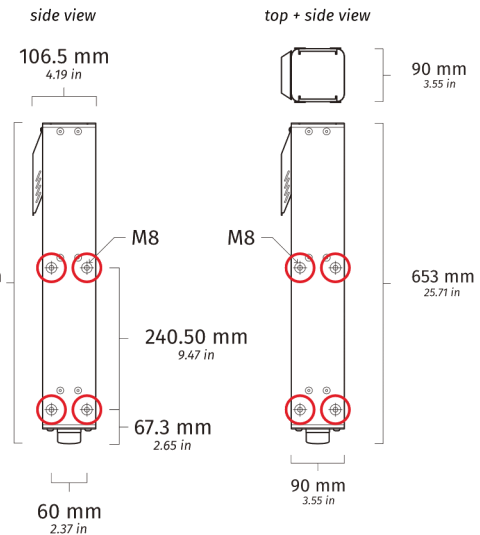

MOTION LOCK

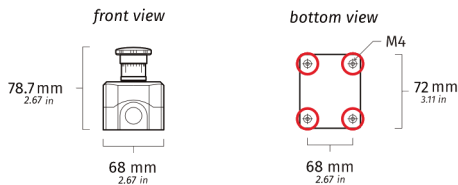

M10

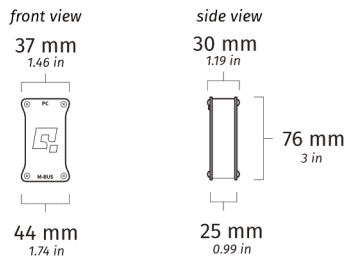

STABILIZATION PLATE



2.4. GROUNDING REQUIREMENTS

INFO

Use only a high-quality power plug adapter purchased from trusted suppliers.

In case of a system malfunction or breakdown, grounding provides a path of the least resistance for electric current to reduce the risk of electric shock. If the place (where the QS-220 is mounted) can not provide proper grounding, according to the description, please contact a qualified electrician for help.

The QS-220 is equipped with an electric cord having an equipment-grounding conductor, and a grounding plug. The plug must be plugged into a matching socket that is properly installed, and grounded in accordance with all local codes and ordinances. It is recommended to use multiple, separately fused wall sockets.

DO NOT modify the plug provided - if it will not fit the outlet, contact adequate technical support.

Applicable plugs for different regions:

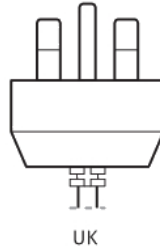

2.5. POWER REQUIREMENTS

Power cabinet QS-SB2 contains the power supply for connected actuators. If there is no certainty if fuses or entire electrical installation can handle QS-220, contact a qualified electrician. Be aware that with heavy payload, and/or more intense simulations average power consumption may rise.

Depending of the chosen operation mode (Heavy Duty, Performance or Q-MODE) power consumption will vary, check point **16.** on page 36 for operation mode selection.

230V ±10% 50-60Hz Single phase	HEAVY DUTY	PERFORMANCE	Q-MODE
Average power consumption - stress test [W]	300	300	500
Average power consumption - typical game [W]	70	40	30
Peak power for converter specification [kVA]	1,5	1,6	2,2
Peak current for breaker specification [A]	7	7	10

120V ±10% 50-60Hz Single phase	HEAVY DUTY	PERFORMANCE
Average power consumption - stress test [W]	300	300
Average power consumption - typical game [W]	50	60
Peak power for converter specification [kVA]	1,5	1,5
Peak current for breaker specification [A]	12	13

INFO

For 120V power supply Q-MODE mode is unavailable

WARNING

Always **UNWIND THE CABLE COMPLETELY** when using a cable reel and untangle an extension cord before connecting the device to the power supply.

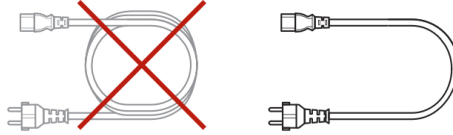

WARNING

Check if the power cord plug has grounding connection (with 3 pins). In order to reduce risk of electric shock **DO NOT** use plug without grounding connection (without center pin).

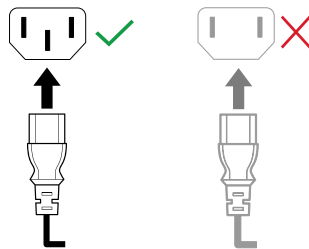

INFO

If motion rigs with two Power Cabinets (4 Actuators Setup) are connected to 120V then each Power Cabinet should be connected to the different wall socket with separate fusing - it might be required, to ensure trouble-free work of the QS-220. The grounding point shall be common.

2.6. ENVIRONMENTAL CONDITIONS

QS-220 shall be operated within ambient conditions as specified below:

- Only indoor use
- Temperature : 0° - 40° Celsius / 32° - 104° Fahrenheit
- Humidity : 0 - 70 % (without water condensation)
- Maximum altitude : up to 2000 m / 6561 ft

3. SETUP AND INSTALLATION

3.1. BEFORE QS-220 INSTALLATION

Qubic System **DOES NOT** approve exceeding or ignoring any of the points below and **IS NOT** responsible for malfunctions, failures or injuries that are results of these actions :

WARNING



Dangerous voltage level may occur in the QS-SB2 power cabinet and connected cables during the operation and for a few minutes after turning off the machine. Do not touch the device when the power switch is on.

WARNING

DO NOT LIFT BY THE CABLE

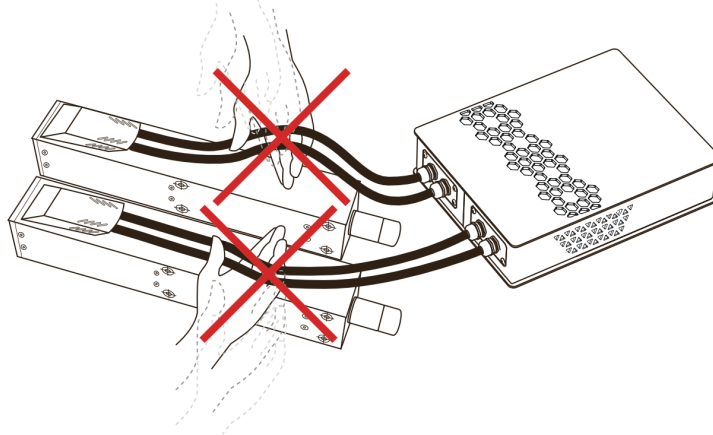

- Cables must not be stretched and should be kept in a way that prevents them from getting under the actuator or any part that can crush or tear them.
- **DO NOT** place down the actuators on the cable side on any surface, always place them down with cable side up to avoid cable damages.

WARNING

- Each Actuator has to be used with the Stabilization Plate and should be placed on a flat surface.
- **DO NOT** use the actuators on very soft or fragile surfaces like rubber, glass, or foam.
- Be aware that QS-220 will crawl a little in every direction during operation. Those movements could damage the surface in the long term. The manufacturer, its subsidiaries and their partners, are not responsible for any floor damages.
- **DO NOT** mount the rig in tight or cluttered spaces – remember that actuators set motions to the rig and nothing should restrict its motion range.
- Seat belts and other harnesses should be mounted as part of the motion rig that move in the same way as the seat. **DO NOT** attach them to any static part or ground.
- If you want to use the QS-220 in an unusual application, and you are not sure, that the desired setup is feasible, contact the distributor/reseller.

3.2. CONNECTING QS-220 TO COCKPIT

- Actuators should be connected to the mounting brackets with 8 screws (M8x20) each.
- Mounting brackets shall be connected to the user rig
- Power cabinet has to be mounted using at least 4 screws (M6x16) – we recommend mount it in the middle of the motion rig. It is possible to mount the power cabinets using the bottom or side mounting holes. Check section 2.3 on page 15.

WARNING

Ensure that the power cabinet does not have a collision with the floor in any position of motion rig.

Example application of connected rig – notice that Actuators have to be perpendicular to the ground:

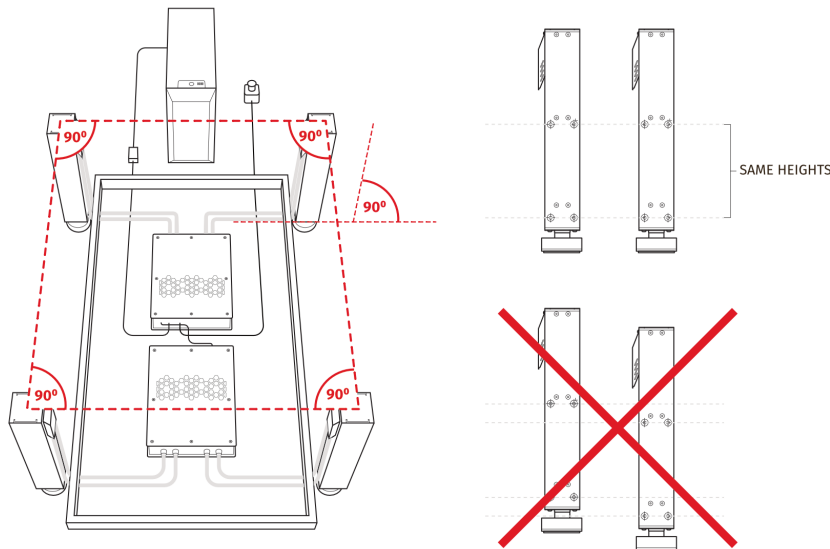

WARNING

Ensure that Actuators are mounted at the same height.

Assure that the motion rig elements does not block air vents of the QS-SB2 power cabinet. The minimum distance between the air vents in the power cabinets and the elements of the cockpit equipment is 10 cm or 4 in.

INFO

The manufacturer is not responsible for quality nor compatibility of the third-party motion rigs.

3.3. ACTUATORS LAYOUT

QS-220 is designed with upgradability in mind – it is possible to expand 2DOF setup to 3DOF later on. Available variants are presented below.

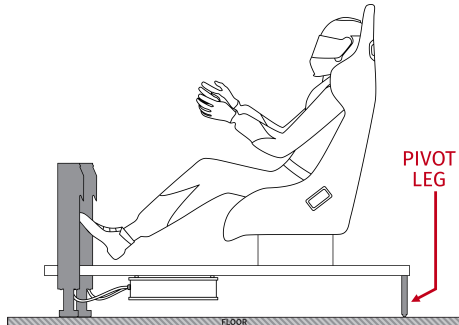

Intro set - 2DOF - Front variant

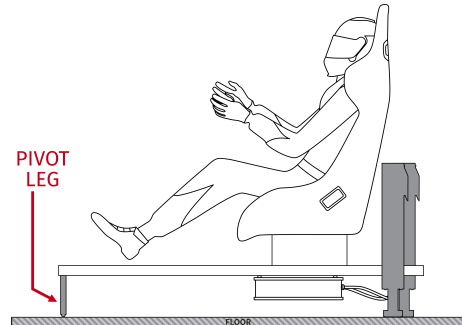

Intro set - 2DOF - Back variant

WARNING

QS-220 is delivered without the pivot leg.

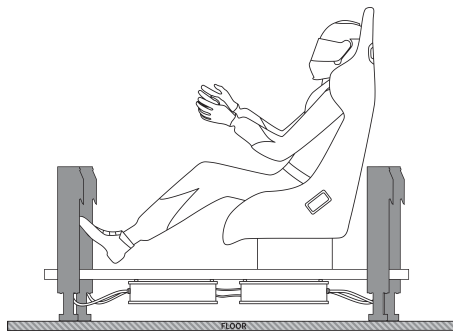

Extended set - 3DoF

3.4. INTRO SET LAYOUTS

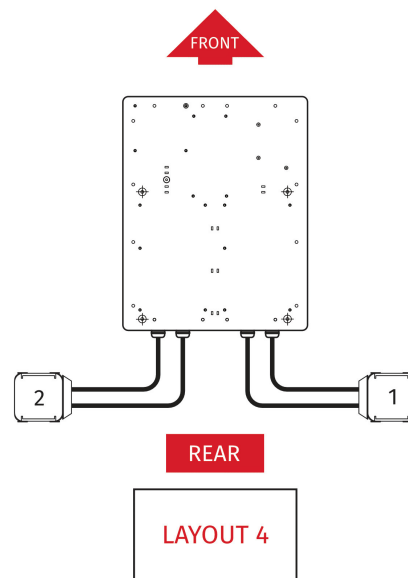
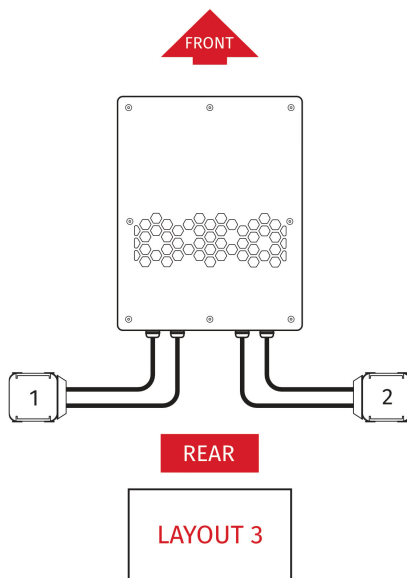
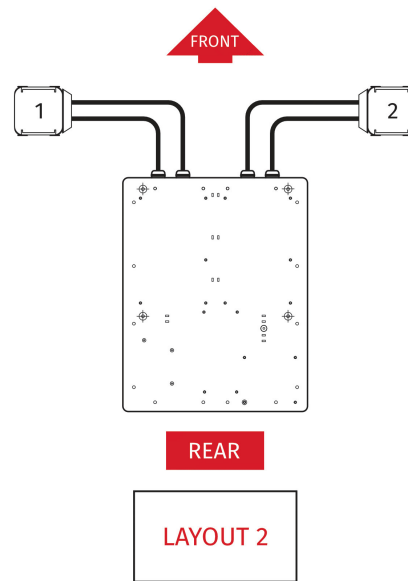
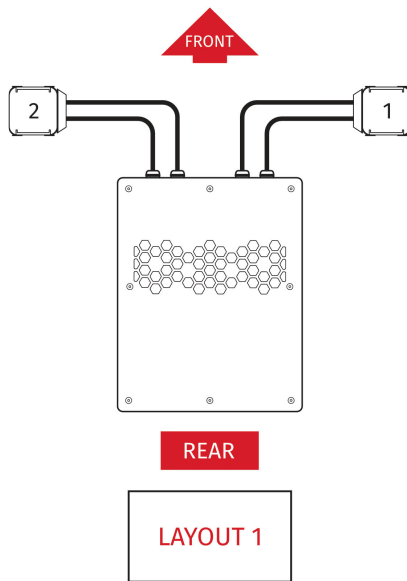

3.5. INTRO SET CABLE CONNECTIONS

To connect QS-220 proceed with following steps and connect the cables according to the connections scheme:

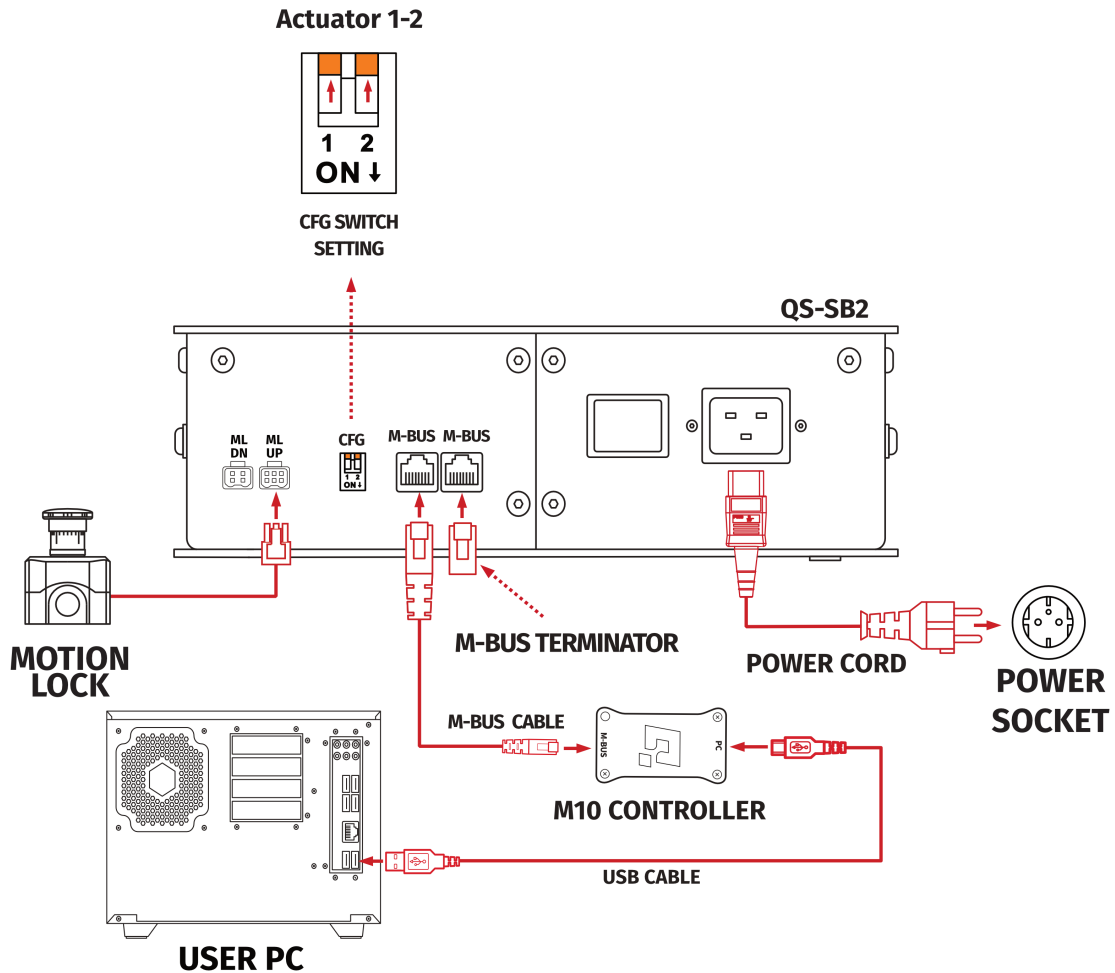

INFO

In the Intro Set keep the CFG switches in the UP position.

Actuator 1 - 2 

For the Intro Set (2DOF) layout setup must be done using QubicManager Software. Go to **QubicManager** → **Tools and Diagnostics** → **Devices** and select **Configure** (check point **10.** on page 34).

1. Plug in the Motion Lock Switch into the "ML UP" port in the QS-SB2 power cabinet.
2. Connect Motion Lock "ML DN" port to Motion Lock "ML UP" port using motion lock interlink cable.
3. Connect M-BUS ports in both power cabinets using BUS communication cable.
4. Put M-BUS terminator in the last M-BUS port in second QS-SB2 power cabinet.
5. Connect M10 to M-BUS port in QS-SB2 power cabinet.
6. Connect PC to the M10 controller using USB cable.
7. In both power cabinets, plug in the power cables with adequate plugs into power sockets.
8. Set the appropriate position on the CFG Switch according to the actuators layout of your choice (more information about CFG Switch position and layout selection in section 3.6).

INFO

Order of connecting the cables is not important, you can connect the M10 controller or Motion Lock Switch to either of the QS-SB2 power cabinet. Keep the CFG switches according to appropriate layout. Check section 3.6 for layout setup.

3.6. EXTENSION SET LAYOUT SETUP

Start the configuration by setting the CFG Switches to the appropriate positions in accordance with one of the eight variants of the power cabinets and actuators installation to the cockpit. Go to **QubicManager** → **Tools and Diagnostics** → **Devices** and select **Configure**.

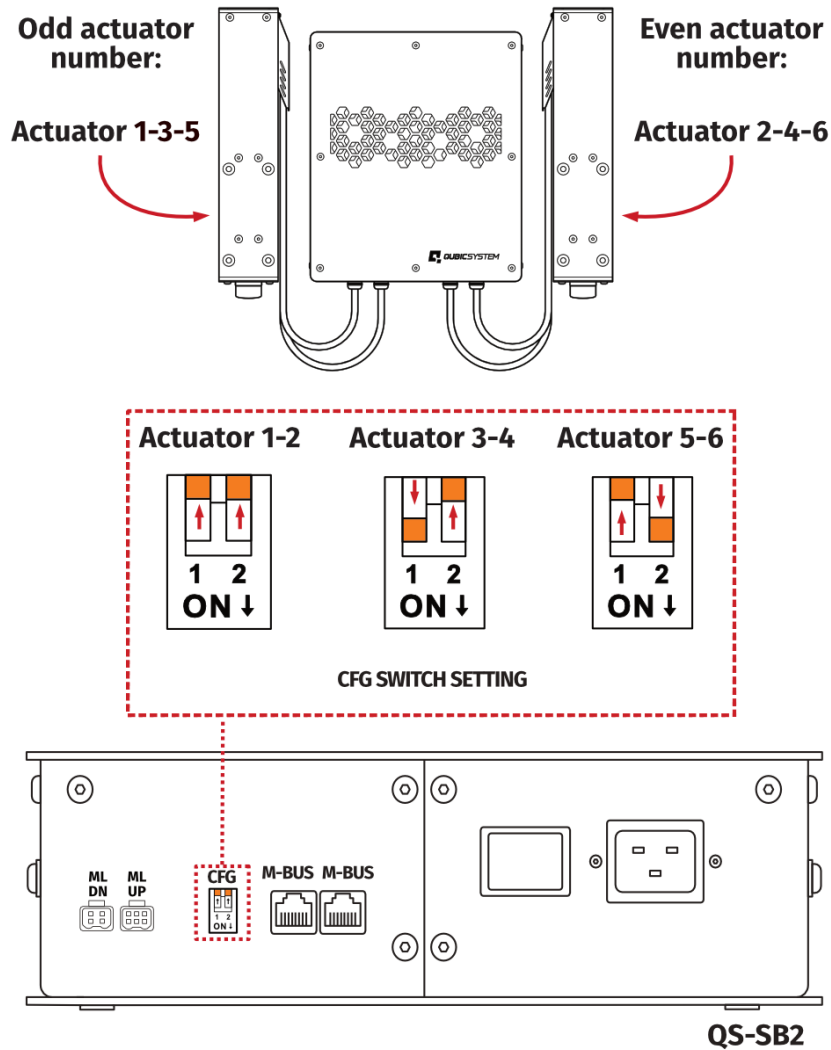

WARNING

- The CFG Switch **CAN NOT** be set in the same position in both power cabinets.
- When changing CFG Switch setting the main power must be **SWITCHED OFF**.
- When changing the CFG Switch setting **FIRMLY SET THE SWITCH** into lower or upper position. Do not leave the switch in the floating position (neither up or down position), otherwise the device will not work.

3.7. EXTENSION SET LAYOUTS

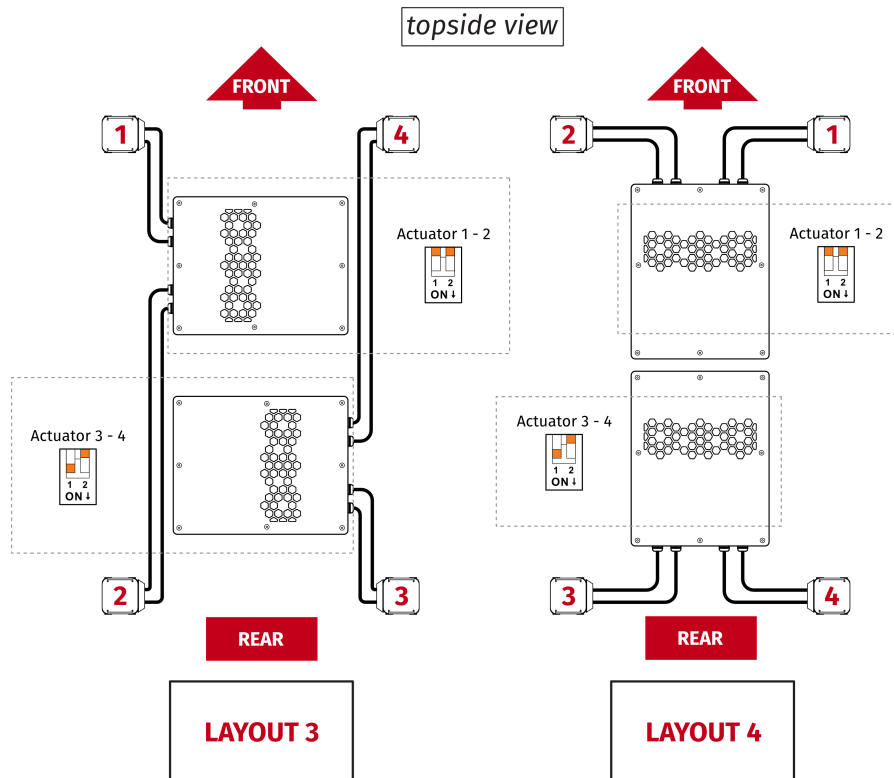
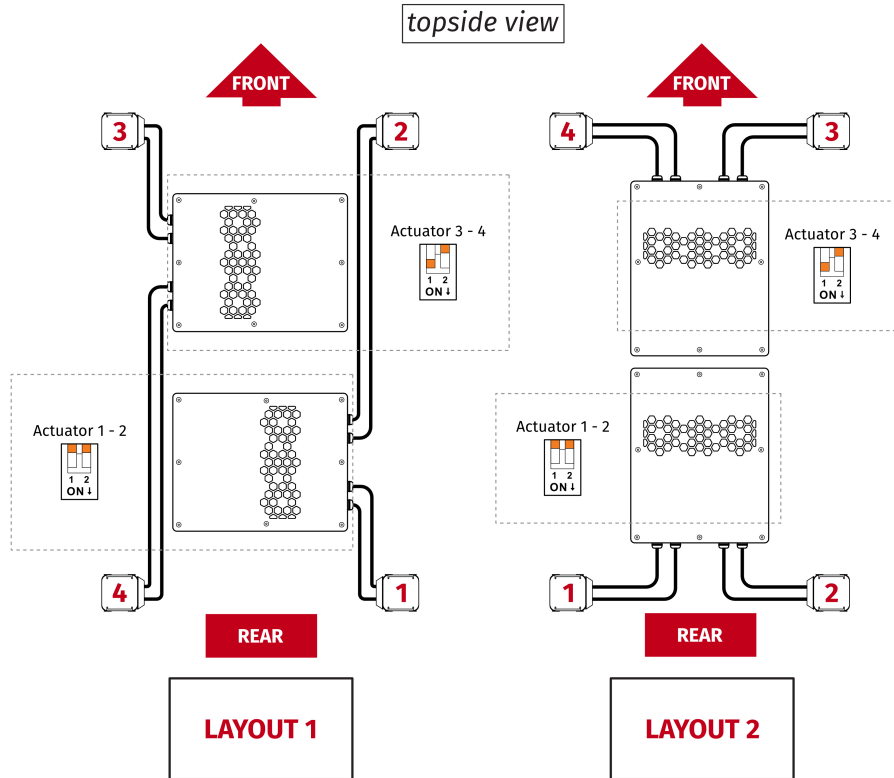

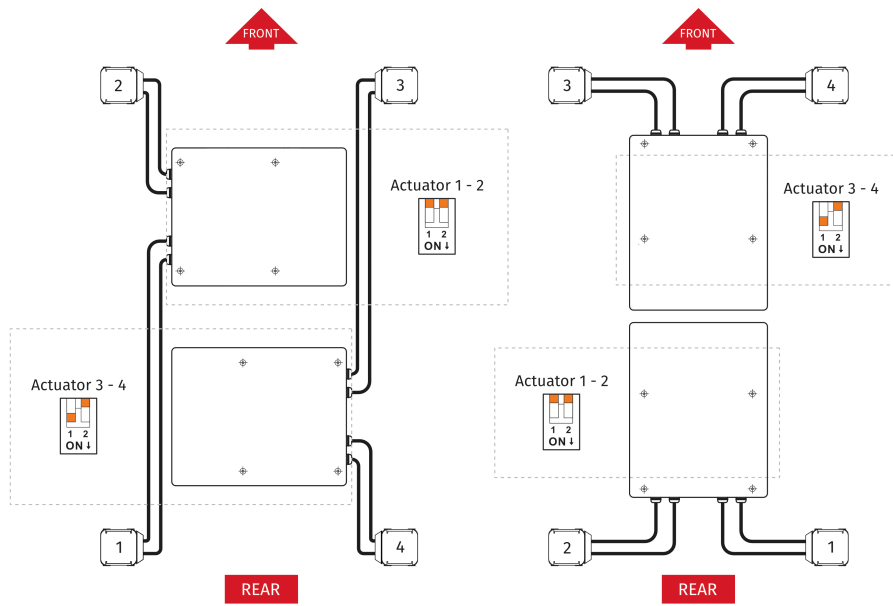

LAYOUT 5

LAYOUT 6

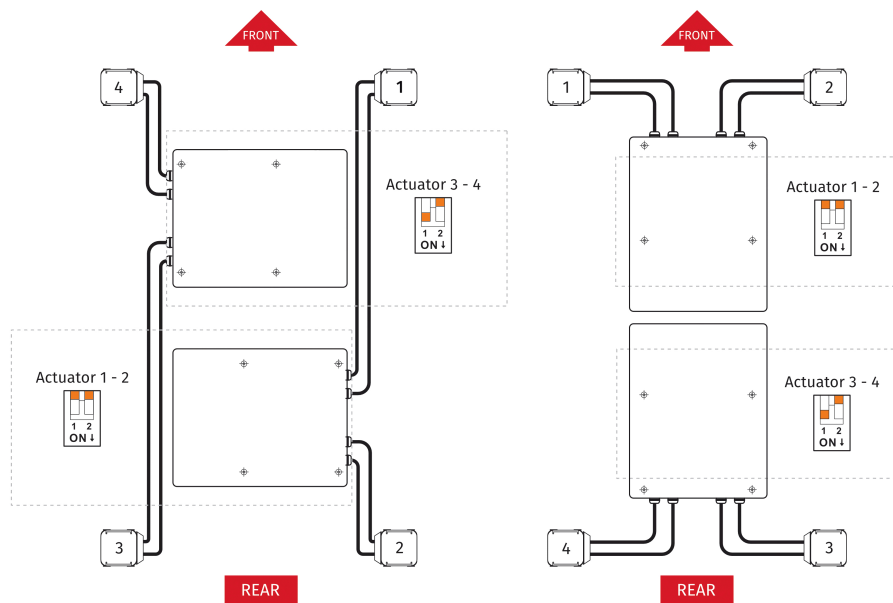

LAYOUT 7

LAYOUT 8

3.8. EXTENSION SET CABLE CONNECTIONS

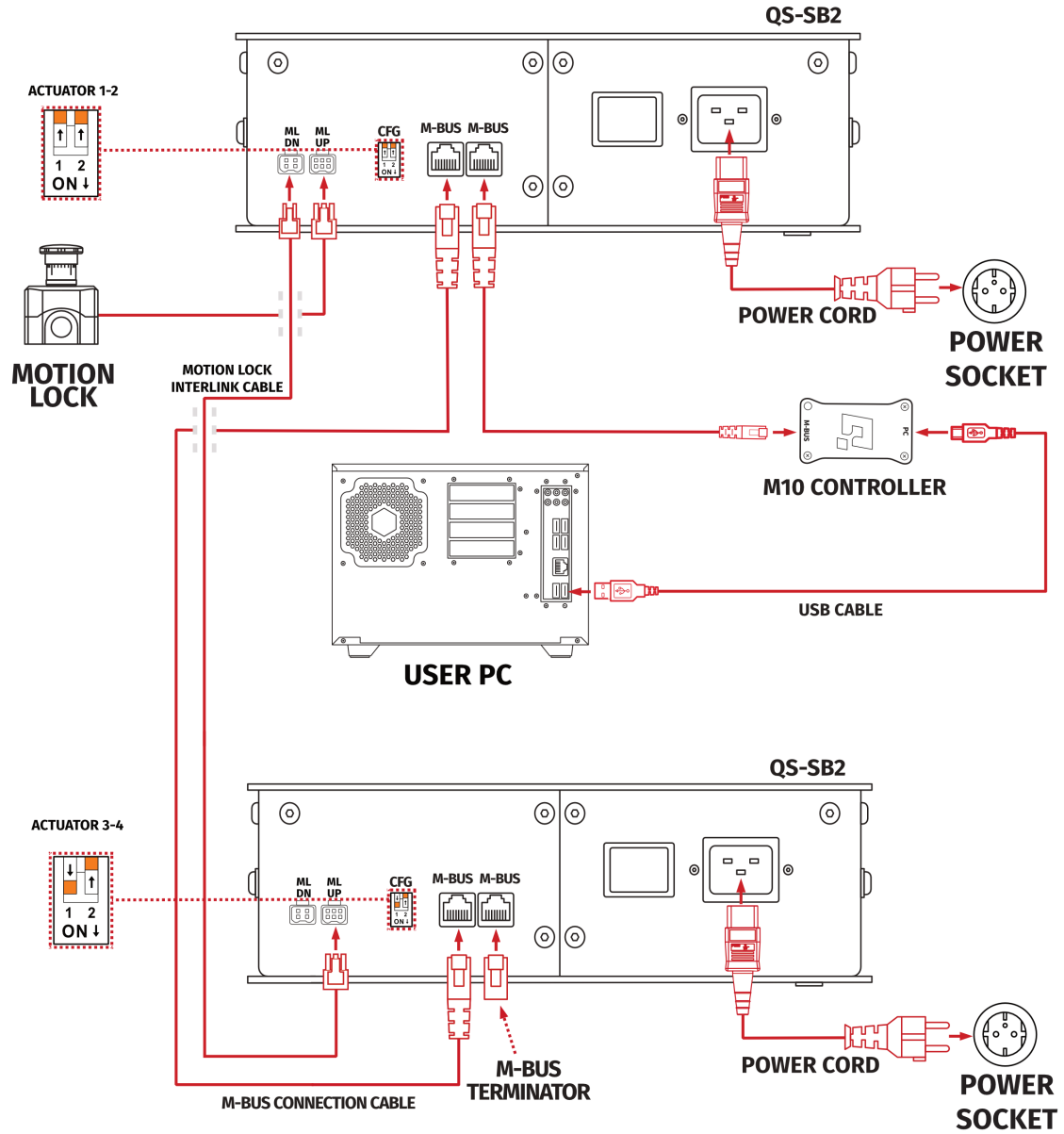

1. Plug in the Motion Lock Switch into the "ML UP" port in the first QS-SB2 power cabinet.
2. Connect Motion Lock "ML DN" port in the first power cabinet to Motion Lock "ML UP" port in the second power cabinet using motion lock interlink cable.
3. Connect Motion Lock "ML DN" port in the second power cabinet to Motion Lock "ML UP" port in the third power cabinet using motion lock interlink cable.
4. Connect M-BUS ports in all power cabinets using BUS communication cable.
5. Put QS-MBT-1 terminator in the last M-BUS port in the third QS-SB2 power cabinet.
6. Connect M10 to the first M-BUS port in first QS-SB2 power cabinet.
7. Connect PC to the M10 controller using USB cable.
8. In all power cabinets, plug in the power cables with adequate plugs into power sockets.
9. Set the appropriate position on the CFG Switch as shown on the connection scheme.

INFO

Order of connecting the cables is not important, you can connect the M10 controller or Motion Lock Switch to either of the QS-SB2 power cabinet. Keep the CFG switches according to appropriate layout. Check section 3.6 for layout setup.

3.9. EXTENSION SET - CONNECTING WITH TRACTION LOSS SYSTEM

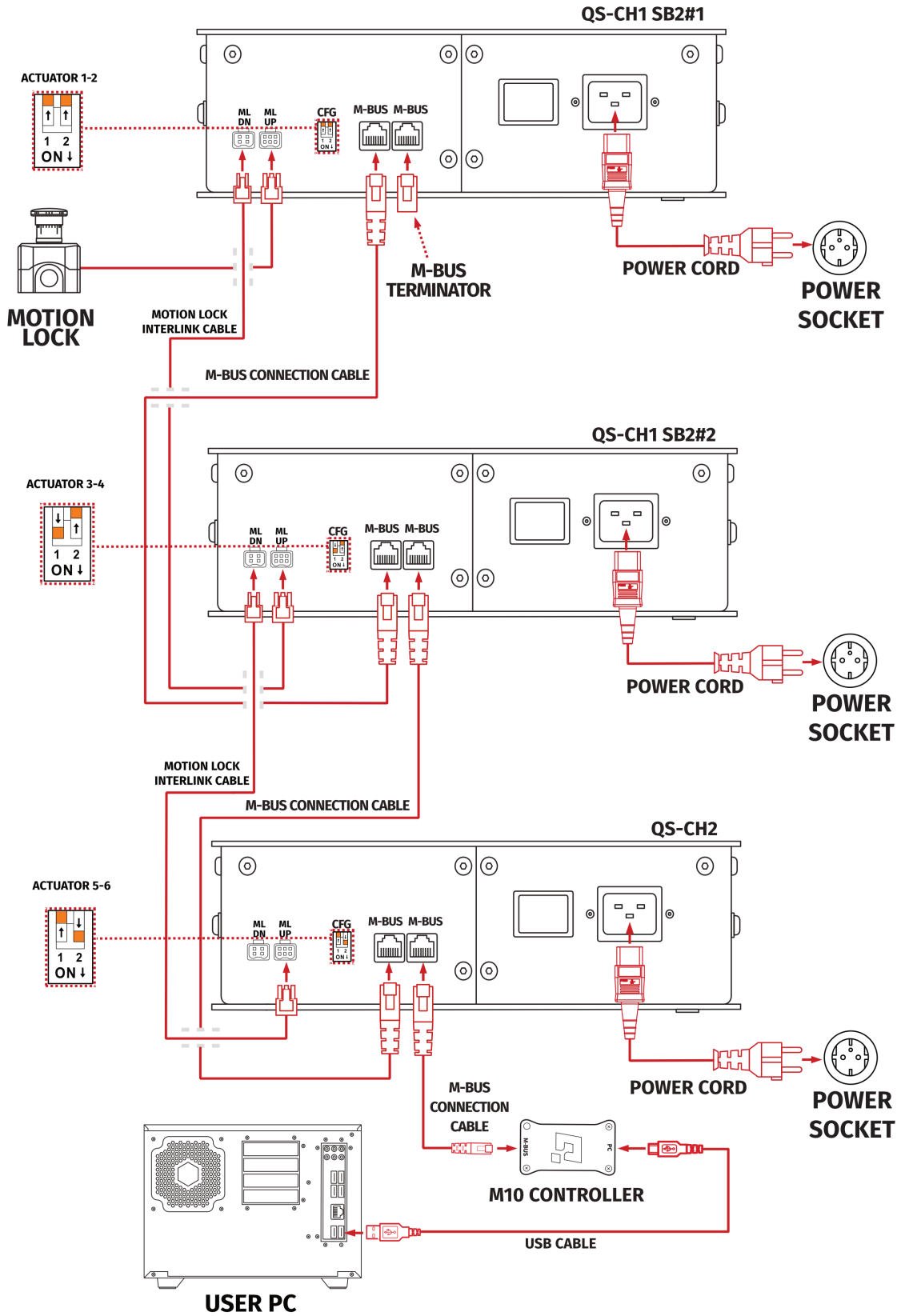

1. Plug in the Motion Lock Switch into the "ML UP" port in the first QS-SB2 power cabinet.
2. Connect Motion Lock "ML DN" port in the first power cabinet to Motion Lock "ML UP" port in the second power cabinet using motion lock interlink cable.
3. Connect Motion Lock "ML DN" port in the second power cabinet to Motion Lock "ML UP" port in the third power cabinet using motion lock interlink cable.
4. Connect M-BUS ports in all power cabinets using BUS communication cable.
5. Put QS-MBT-1 terminator in the last M-BUS port in the third QS-SB2 power cabinet.
6. Connect M10 to the first M-BUS port in first QS-SB2 power cabinet.
7. Connect PC to the M10 controller using USB cable.
8. In all power cabinets, plug in the power cables with adequate plugs into power sockets.
9. Set the appropriate position on the CFG Switch as shown on the connection scheme.

INFO

- Order of connecting the cables is not important, you can connect the M10 controller or Motion Lock Switch to either of the QS-SB2 power cabinet. Keep the CFG switches according to appropriate layout. Check section 3.6
- When connecting QS-CH2 to other Qubic System devices which uses two QS-SB2 power cabinets the CFG switch on the QS-CH2 must be set to actuator 5-6 position.

3.10. SOFTWARE INSTALLATION

The **SERIAL NUMBER** can be found on the M10 identification label in the **XXXXXX-XXXXXX-XXXXXX-XXXXXX** format. This serial number is also used for activation of FSMI (ForceSeatMI) and MT (Motion Theater) licences - check information on page 38.

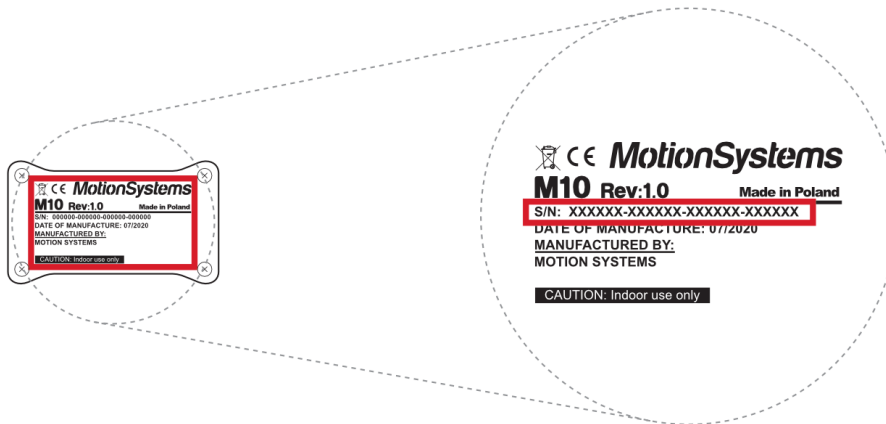

Software installation procedure:

1. Connect the devices according to the cables connection scheme - see section 3.5 or 3.8
2. Download QubicManager from [QubicSystem.com/Download](https://www.qubic.com/Download)
3. Enter the serial number located on the identification label.

INFO

Alternatively you can download a small program that can read code directly from your device when it is connected via USB : [Download link](#)

4. Proceed with the installation steps and launch the application.
5. Turn on the device by switching on the power switch button on the QS-SB2 power cabinet (on both if you have two sets)

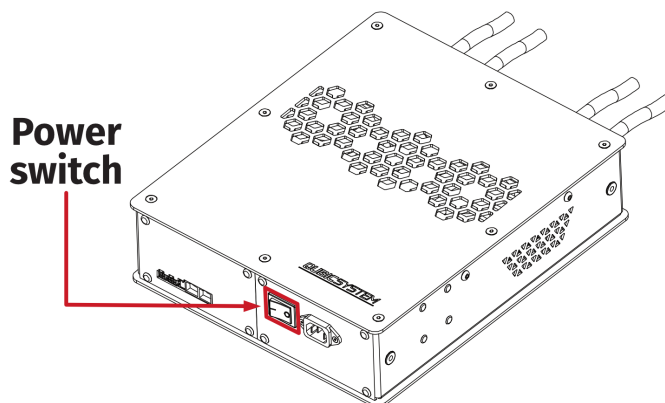

6. Check position of Motion Lock Switch, unpress if needed.
7. The QS-220 will perform a start-up calibration.

WARNING

DO NOT change the payload during the start-up calibration.

8. If QubicManager has recognized the QS-220 correctly, the status of the machine visible in the lower left corner will change to **Connected**.
9. Check **Action Center** on the right side panel for a list of actions that requires attention:

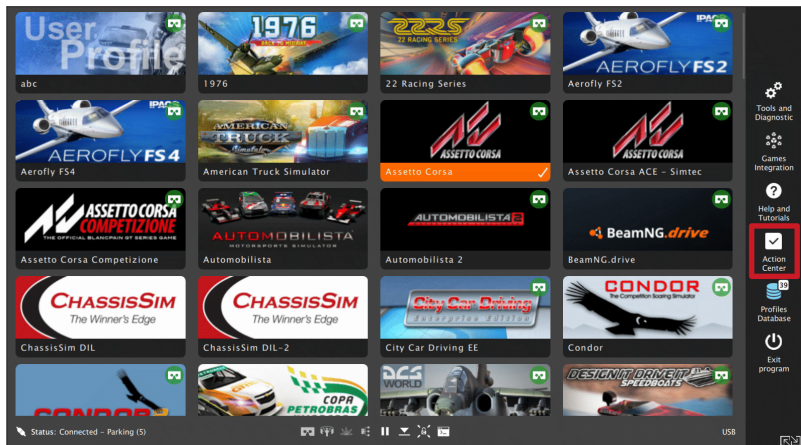

It is possible to solve them one by one or by pressing the **Resolve All** button. Firmware update may require additional confirmation in the dialogue box.

10. Go to **Tools and Diagnostics** → **Devices** and select **Configure**.

Below are all recognized devices including motion platforms and accessories.

Device #1:	OS-4xx		Configure
Serial number:	xxxxxx-xxxxxx-xxxx-xxxxxx	(copy to clipboard)	Levelling
Status:	OK		Quick Codes
Firmware:	141.16	Temperature (C): N/A	
Work time:	1h 05m 17s	Up time: 0h 21m 02s	
Paused:	no	Parking: finished (normal)	
Hardware ID:	54	Features: default	
Offline:	no		
Device #1.1:	HVFMCI00		
Serial number:	xxxxxx-xxxxxx-xxxx-xxxxxx	(copy to clipboard)	
Status:	OK (33)		
Firmware:	144.30	Temperature (C): 24, 31	Hardware ID: 58
Work time:	-	Up time: 0h 20m 29s	Features: default
Device #1.2:	HVFMCI00		
Serial number:	xxxxxx-xxxxxx-xxxx-xxxxxx	(copy to clipboard)	
Status:	OK (33)		
Firmware:	144.30	Temperature (C): 24, 31	Hardware ID: 58
Work time:	-	Up time: 0h 20m 29s	Features: default

11. For intro set: Choose the correct layout variant from the list (2 actuators setup).

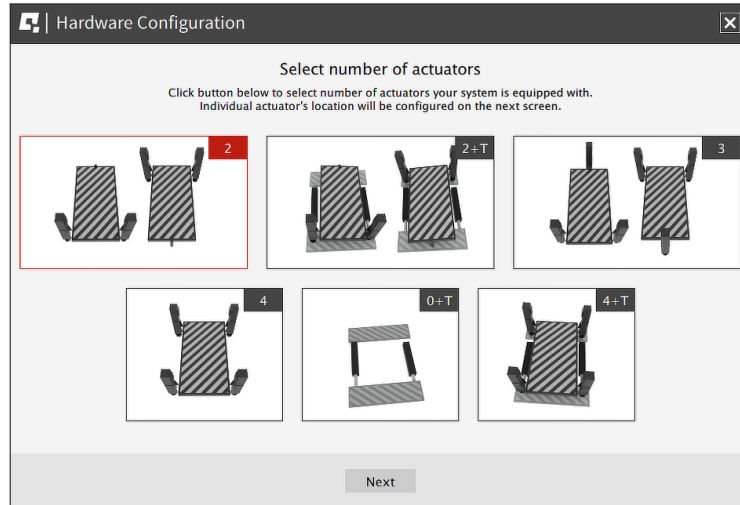

12. For extended set: Choose the correct layout variant from the list (4 actuators setup).

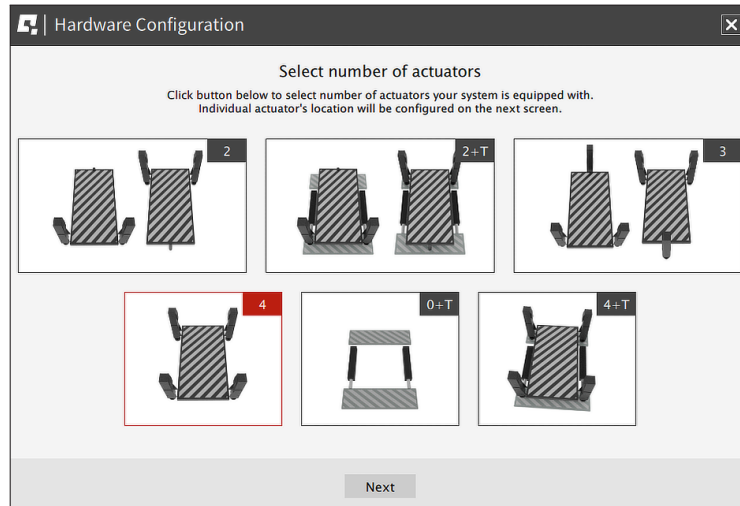

13. For extended set with traction loss control: Choose the correct layout variant from the list (4+T setup).

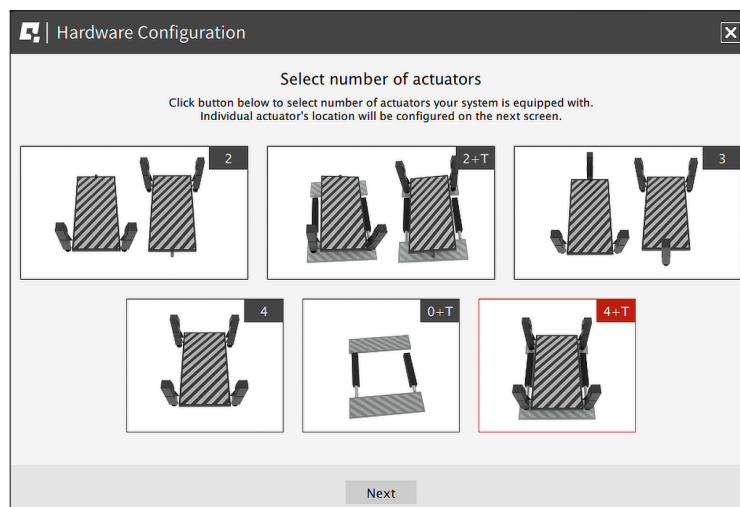

14. Measure the width between front side actuators. Put in the value in the platform dimensions **Width** field (in millimetres).
15. Measure the length between front and rear side actuators. Put in the value in the platform dimensions **Length** field (in millimetres).

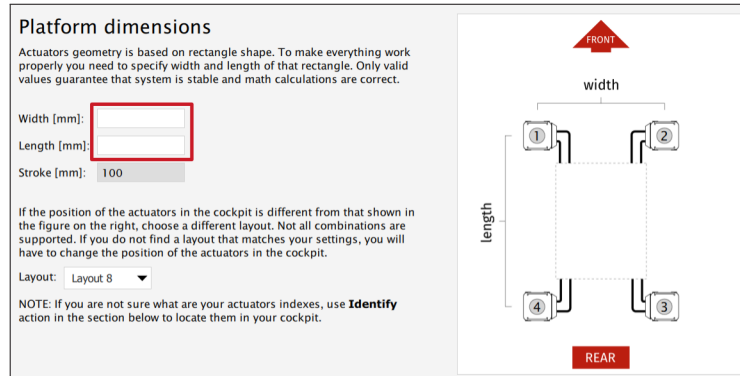

16. Scroll down in the window, you can choose one of the operation modes:

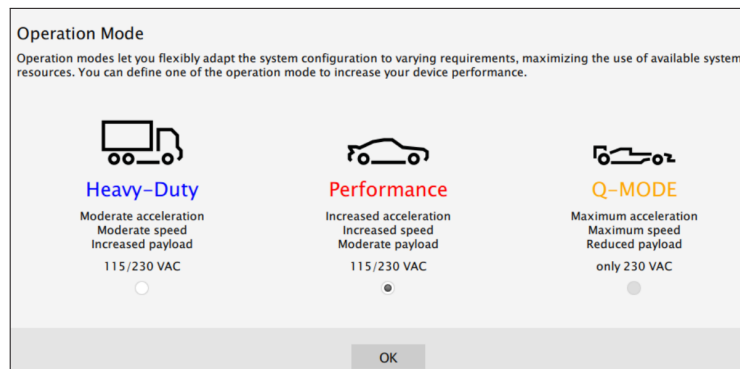

17. Close the configuration and return to the main application window. Choose the game and check profile details by clicking on the game tile.

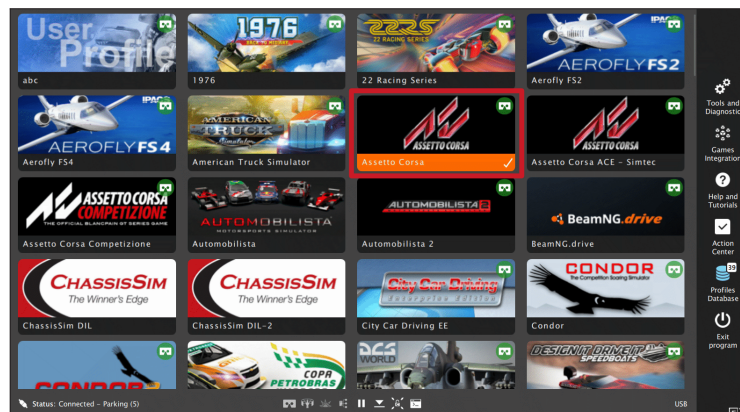

- Adjust the motion effects intensity to your preferences in the game profile window, scroll down in the window to see all of the settings. You can adjust the settings during the game simulation by pressing **ALT+TAB**.

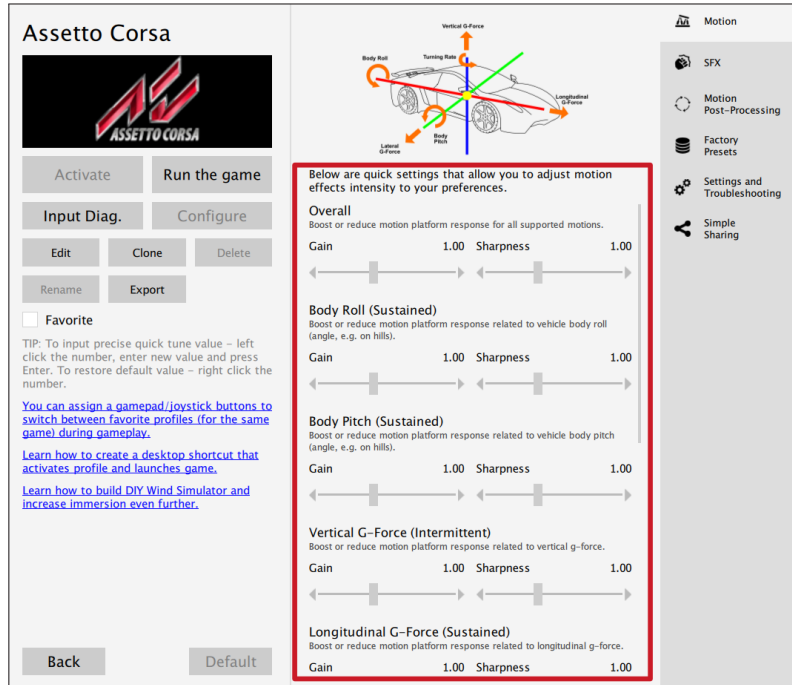

- Activate profile by clicking the **Activate** button.

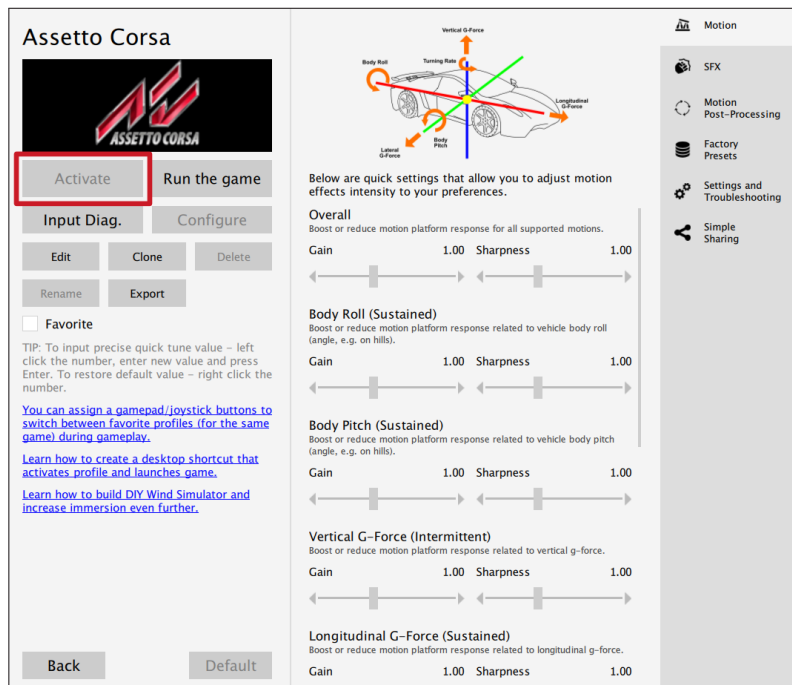

20. Launch on the game by clicking the **Run the game** button.

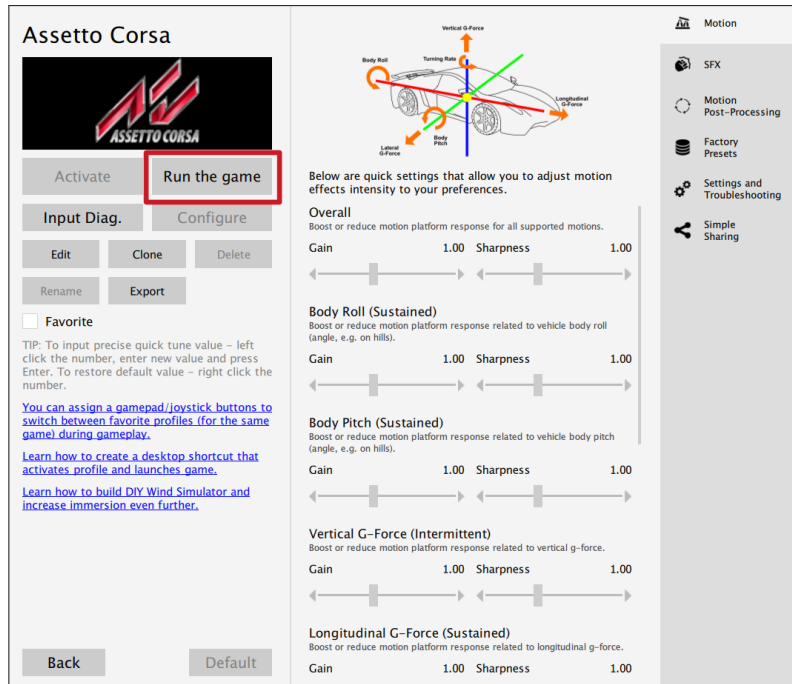

INFO

If you need the serial number to activate other software licences such as ForceSeatMI or ForceSeatDI, it can be found in the QubicManager. After connecting the QS-220 go to **Tools and Diagnostics** → **Devices**. Serial number is visible under the device name:

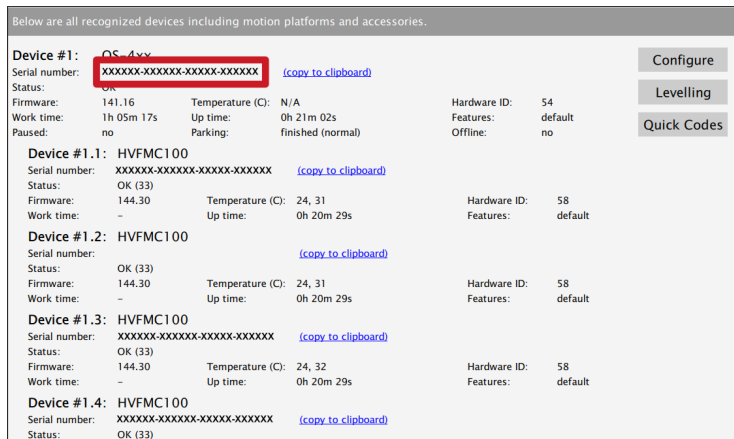

WARNING

The software is provided "as is", without warranty of any kind, express or implied, including but not limited to the warranties of merchantability, fitness for a particular purpose, and non-infringement. In no event shall the authors or copyright holders be liable for any claim, damages, or other liability, whether in an action of contract, tort or otherwise, arising from, out of, or in connection with the software or the use or other dealings in the software. The software sends anonymous usage data to the Motion Systems company. The data is used to improve the software and game profiles. The data is not used for advertising purposes.

4. MAINTENANCE AND CLEANING

To minimize the risk of abnormal heating that can result in system failure, keep the QS-220 uncovered, clean and dust-free. Cleaning of the unit shall be performed only with a soft, dry cloth. **DO NOT** use any chemicals, water and other liquids to clean the device.

At least once a month, check if Motion Lock Switch is working correctly – turn on the QS-220 (when no one is using the rig) and push the red button. If the machine turns off and does not react to any signal (turn on simulation or game to check it) then Motion Lock Switch works properly. If the machine reacts in any different way, stop using it and contact the technical support immediately.

To minimize the risk of QS-220 failure, check the condition of the linear actuator's rubber seals once a month, and lubricate them externally, if necessary, using a viscous lubricant spray with dispenser.

5. TROUBLESHOOTING

WARNING

DO NOT attempt to do any repairs by yourself. It is dangerous and voids the warranty! Repairs should be consulted with technical support and then performed by a qualified technician.

Before contacting technical support, try this:

- Check Action Center in QubicManager.
- Check all cable connections in the device.
- Restart QubicManager application by right-click on the application icon in the system tray and selecting **Restart**:

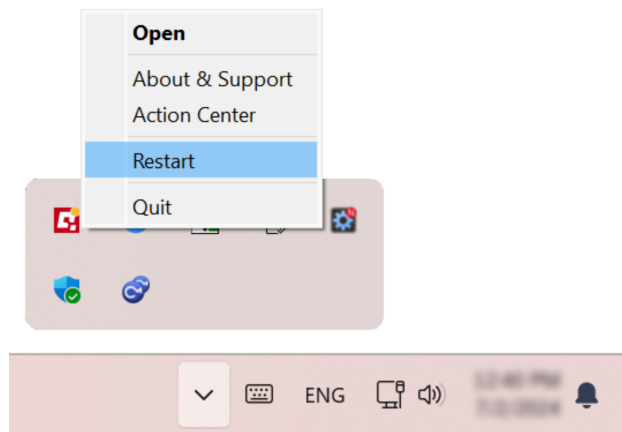

- Check Motion Lock Switch position (it should be unpressed to activate the motion)

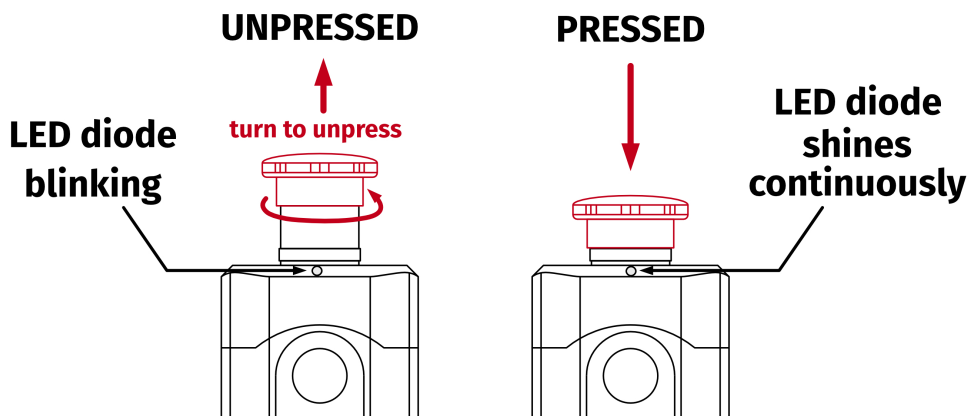

- Try different USB ports.
- If a problem occurred abruptly, it could be caused by a thermal protection. Turn off the QS-220, disconnect it from power outlets and wait at least 15 minutes to let it cool down. Try turning it on again later.

- In case of any unclear electrical issues or strange behavior, contact technical support
- If the device suffers from abnormal work conditions, please immediately contact the distributor/reseller for technical support.

5.1. CREATING A SNAPSHOT

A snapshot is the easiest and fastest way to diagnose a problem. If you send in the zip file generated in the snapshot menu along with a description of the problem, technical support receives the necessary information about the product and its configuration. It can be then analyzed to provide the best solution.

WARNING

The QS-220 and all interconnected Power Cabinets **MUST BE** powered up when creating the snapshot.

1. Open the main window of the QubicManager application.
2. Go to **Tools and Diagnostic** → **About / Support**.

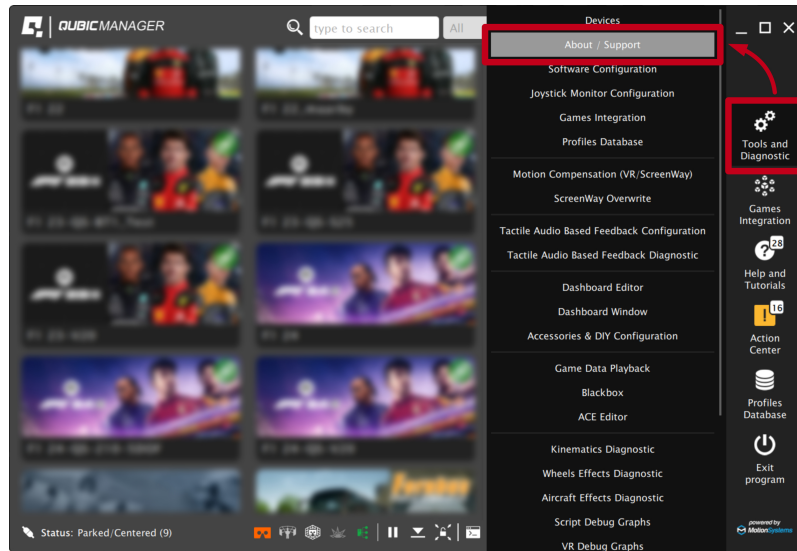

3. Open the **Snapshot** window:

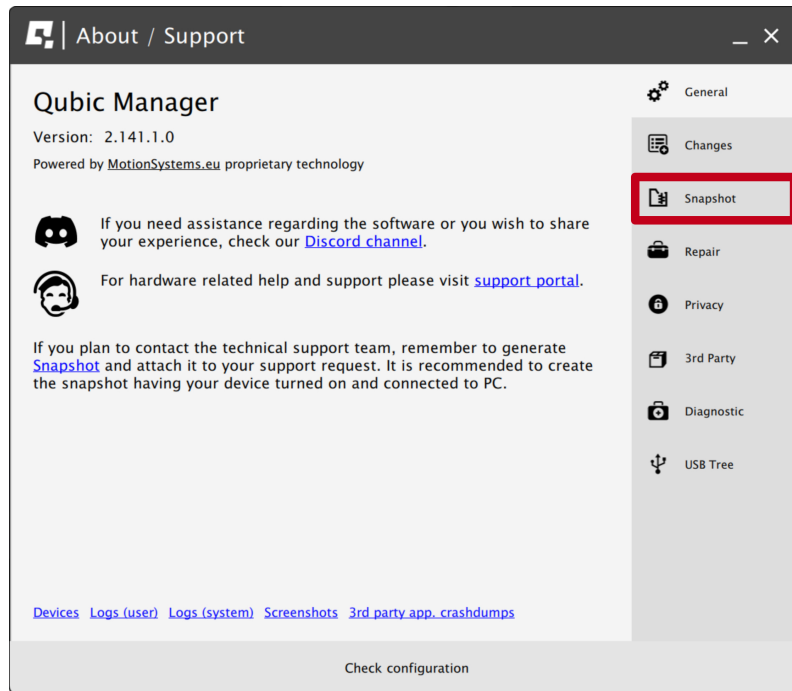

4. Select data that will be included in the snapshot.
5. Scroll down, consent to the technical support terms and conditions and select **Create & Show**:

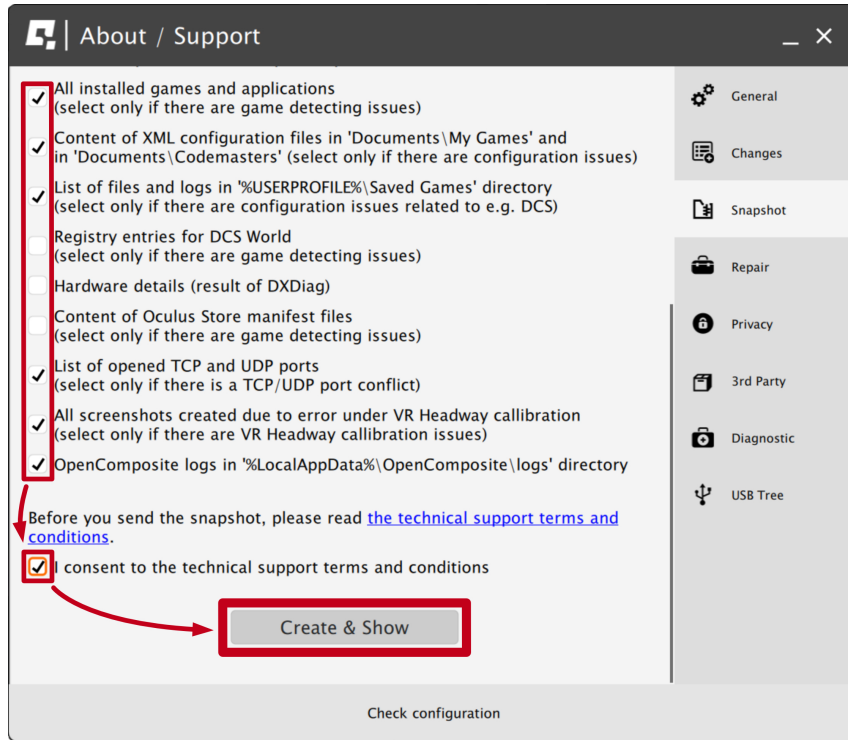

6. The snapshot has been created, click the **OK** button - the folder with the snapshot ZIP file will open.

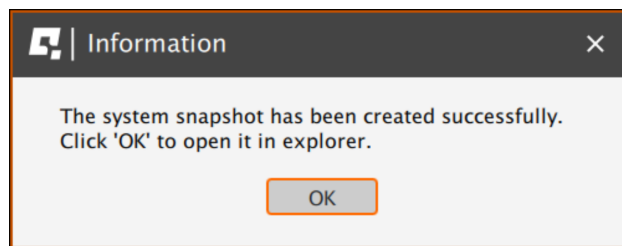

7. Attach the snapshot ZIP file to your support request.

5.2. DISCORD CHANNEL

We strongly recommend joining our discord channel, where our growing community is sharing amazing tips and ideas of how to set up, use and tune the Qubic System products. You can also send questions for technical support or get answers directly from the community.

Join our discord channel by following the invitation link:

<https://discord.com/invite/tuAtybvTRn>



6. ADVANCED APPLICATIONS

INFO

Examples shown in this section describes optional application of external safety and power cut-off devices. If you wish to expand the functionality of your motion system, read the whole section to have a good understanding of how to apply and what functionality to expect. Apply at your own discretion.

WARNING

Motion Lock input is not a SIL/PL (safety integrity level/performance level) rated and **DOES NOT** guarantee safety. If you wish to achieve specific SIL/PL ranking, consider introducing a power cut-off device that is controlled by an external safety relay and cuts off the power to all QS-SB2. Example application of the power cut-off contactor can be found in section 6.3.2 and 6.3.3.

INFO

When applying safety relay to the Motion Lock :

- Use input cables according to your safety relay manual.
- Use output cables according to your safety relay manual and cross section no less than 0,75 mm²

6.1. ADDING ADDITIONAL DEVICES TO THE MOTION LOCK CIRCUIT

If there is necessity to stop other devices, apart from the QS-220, ML (Motion Lock) and additional user devices can be controlled by safety relay outputs. In the example application, the E-STOP button is connected to the external safety relay. When the E-STOP is triggered, the safety relay will activate the Motion Lock function, which will stop motion of the platform and additional devices.

Example application of single-channel safety relay that controls ML and additional devices :

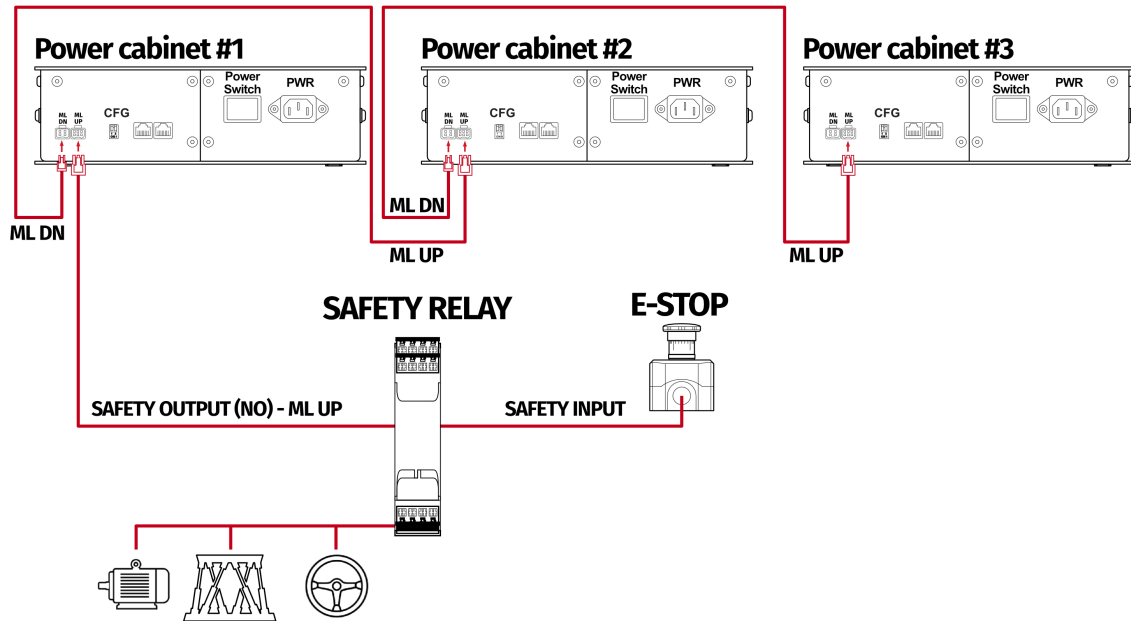

Example wiring diagram of application of one-channel safety relay with E-STOP button:

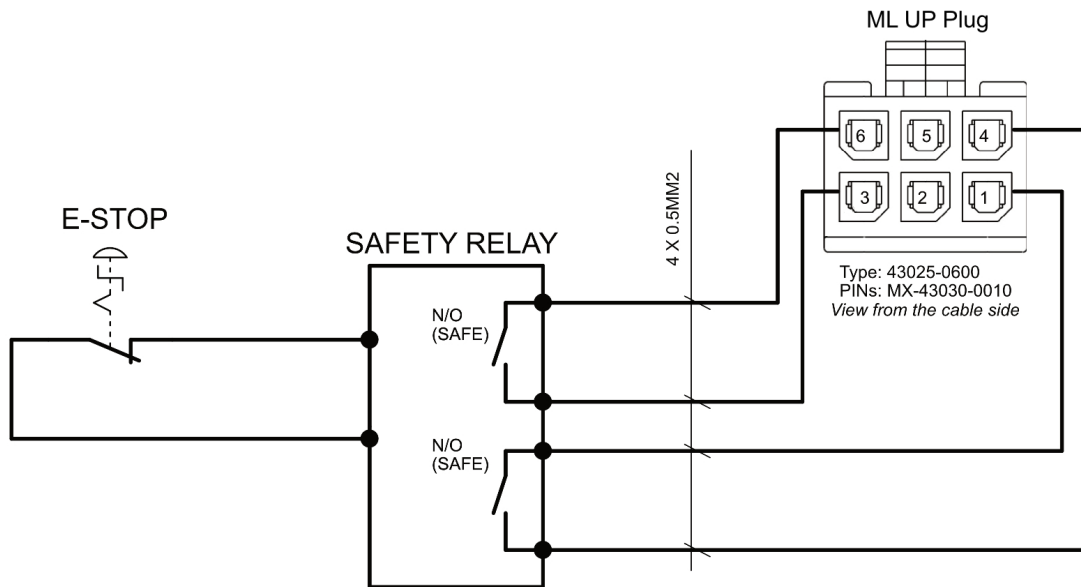

6.2. IMPLEMENTING THE WORKING ZONE PROTECTION

For protection against accidental hit from moving parts of the platform, safety gate with opening sensor* can be connected to safety relay input for activating ML function. When the gate is opened, the safety relay output activates the ML (Motion Lock) function and stops the motions of the platform.

Example application of safety gate opening sensor:

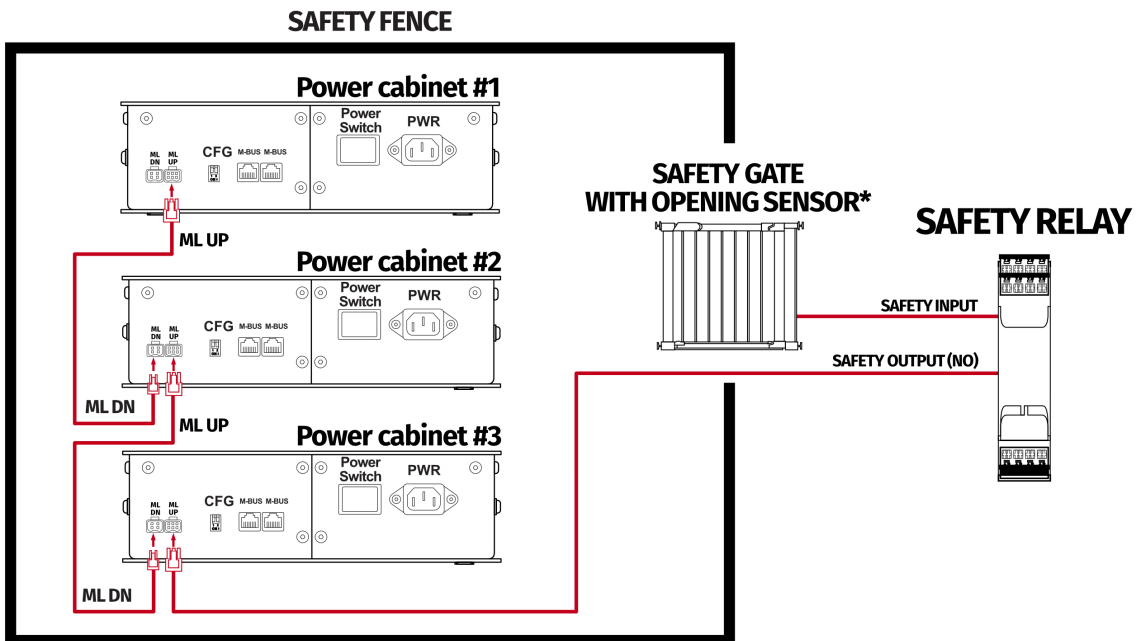

*Check your safety relay manual for list of applicable sensors

6.3. INCREASING SAFETY LEVEL

WARNING

Modifications of the safety system, involving application of the power line contactors, shall be performed only by a competent person. A competent person is a qualified and knowledgeable person, who because of their training, experience has the knowledge required to apply those changes. It is user responsibility to commission modification of the safety system to a competent person, experienced with industrial wiring practices, which will be required to undertake the installation. Commissioning shall be undertaken by a trained electrical technician experienced in safety installations.

6.3.1 ASSEMBLING MOTION LOCK JUMPER

To apply solutions which require to use power line contactors, Motion Lock connection cables in the QS-SB2 power cabinet needs to be replaced with jumpers, which are not provided with the QS-220. To prepare jumper, you need to assemble recommended connector as shown below :

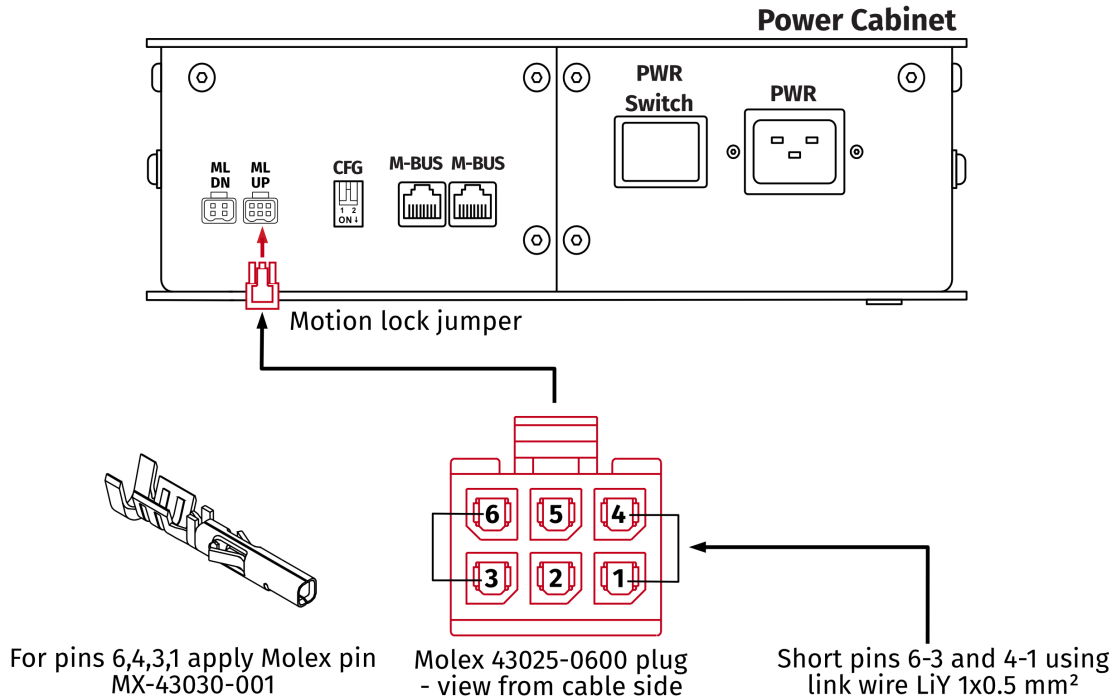

6.3.2 ADDING POWER-CUT CIRCUIT WITH E-STOP BUTTON

If specific SIL/PL rated level needs to be achieved, it might be necessary to install a power cut-off device. Two contactors connected in series and controlled by safety relay can be used to provide or cut-off power line to QS-SB2 power cabinets. When safety function on safety relay input is triggered, a safety relay will switch off the contactors, thus cutting-off the power to the platform. To apply this solution, ML UP connection cables needs to be replaced with prepared jumper as described in section 6.3.1

INFO

To achieve required safety performance level it is necessary to perform safety risk assessment at user site.

Example application of power line contactors and E-STOP button:

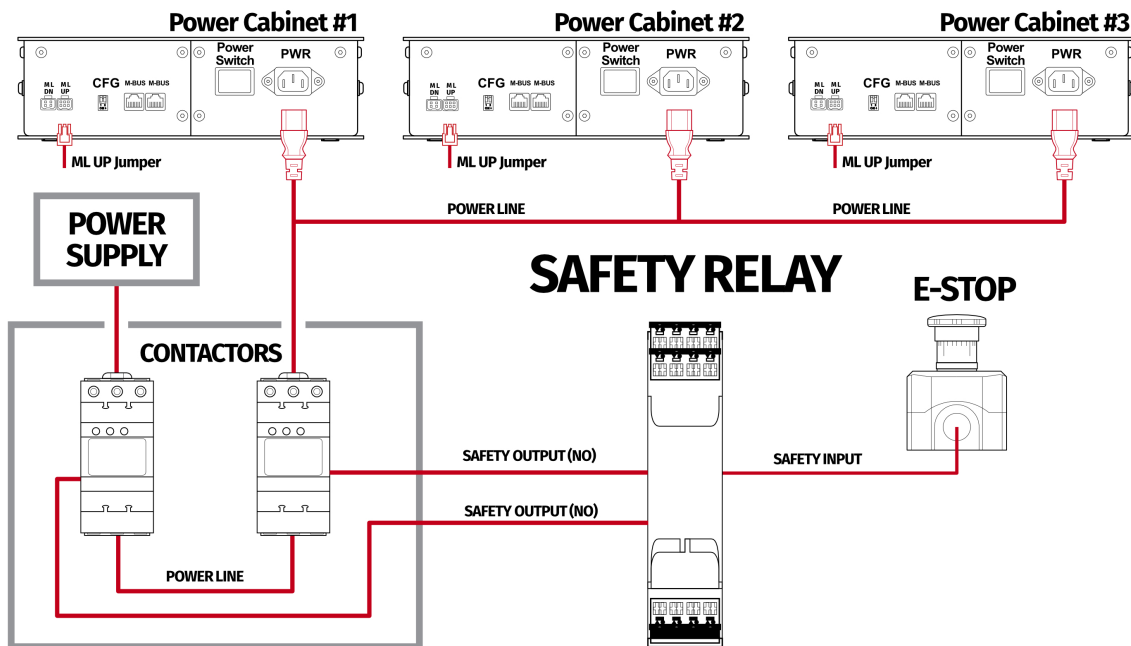

INFO

In order to increase SIL/PL level it's a good practice to apply well-known contactors of two different manufacturers in order to decrease probability of failure resulting from serial production.

Example wiring diagram of application of power line contactors and one-channel safety relay with E-STOP

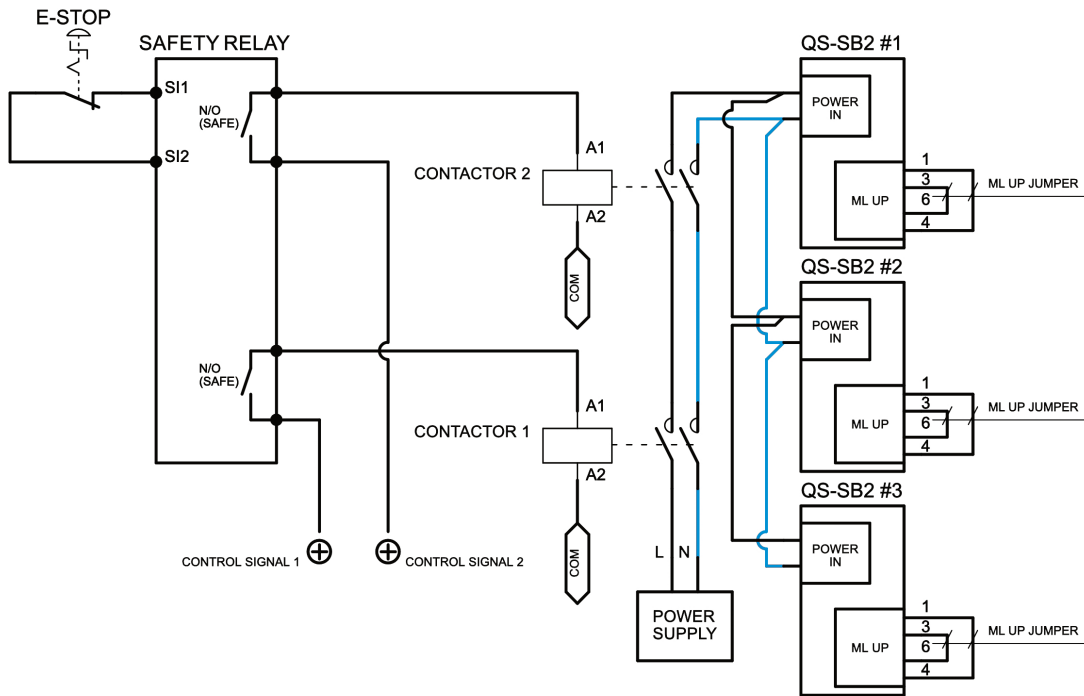

INFO

PE (protective grounding/earthing) connection is omitted for better transparency

6.3.3 IMPLEMENTING THE WORKING ZONE PROTECTION WITH POWER-CUT CIRCUIT

In example application contactors connected in series provide power line to the QS-SB2 power cabinets. When safety function on safety relay input is triggered, a safety relay will switch off the power contactors, thus cutting-off the power to the platform.

Example application of power line contactors with safety gate opening sensor:

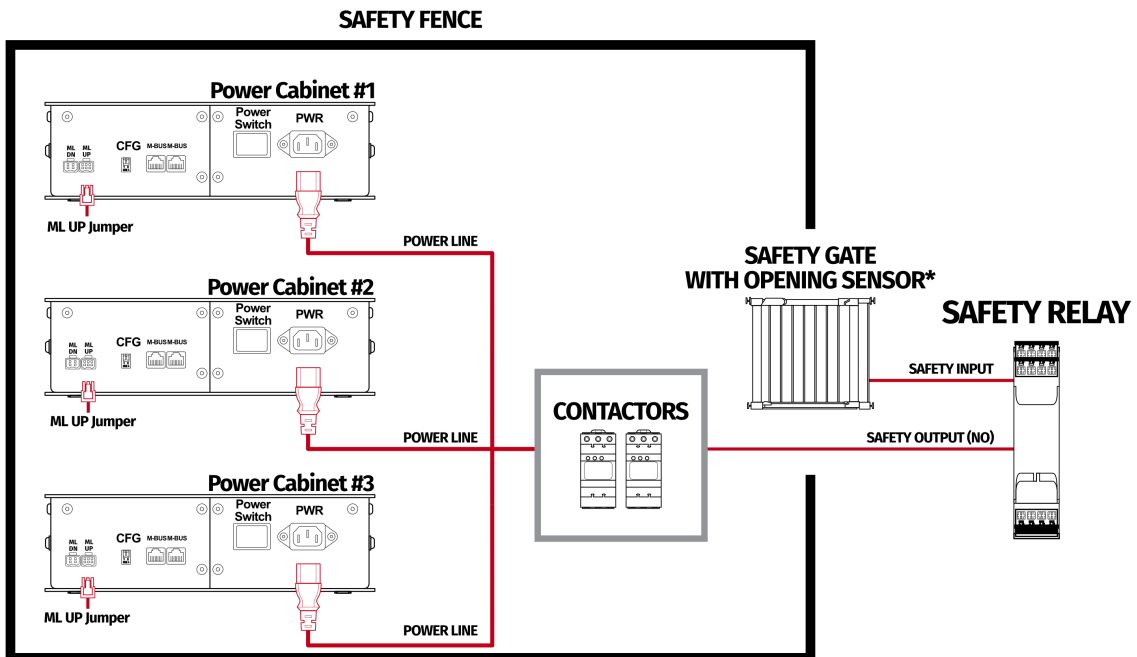

*Check your safety relay manual for list of applicable opening sensors

INFO

When applying safety relay and contactors to the power line remember to:

- Use control cables according to your safety relay manual
- Power line cables shall be chosen accordingly to power requirements of motion system. See power requirements of specific motion system.

7. ENVIRONMENTAL IMPACT AND DISPOSAL

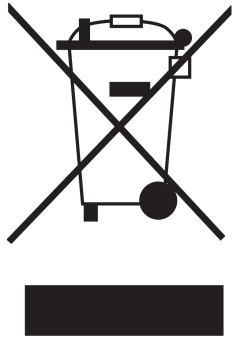

DO NOT dispose of this product with standard household waste, but dropped it off at a collection point for the disposal of Waste Electrical and Electronic Equipment for recycling.

QS-220 is an advanced device and if stored or disposed of incorrectly, it could harm the environment or/and other people. Please contact your local authorities for information at the collection point nearest you.

8. LIABILITY DISCLAIMER

If permitted under applicable law, Motion Systems and its subsidiaries disclaim all liability for any damages caused by one or more of the following:

- The product has been modified, opened, or altered.
- Failure to comply with the User Manual.
- Inappropriate or abusive use, negligence, an accident (an impact, for example).
- Normal wear.

INFO

If permitted under applicable law, Motion Systems and its subsidiaries disclaim all liability for any damages unrelated to the material or manufacturing defect with respect to the product (including, but not limited to, any damages caused directly or indirectly by any software, or by combining the QS-220 with any unsuitable element or not other elements not supplied or not approved by Motion Systems for this product).

9. WARRANTY

Motion Systems warrants to the consumer that this product shall be free from defects in materials and workmanship, for a warranty period which corresponds to the time limit to bring an action for concerning this product.

For commercial customers, there is a one (1) year limited warranty, starting on the original date of purchase.

Within the warranty period, the product will be repaired or replaced free of charge, excluding shipping charges.

This warranty shall not apply:

- If the product has been modified, opened, altered, or has suffered damage as a result of inappropriate or abusive use, negligence, an accident, normal wear, or any other cause unrelated to a material or manufacturing defect (including, but not limited to, combining the QS-220 with any unsuitable element, including in particular power supplies, chargers, or any other elements not supplied or approved by Motion Systems for this product).
- In the event of failure to comply with the instructions provided by technical support.
- To software, said software being subject to a specific warranty.
- To accessories (cables, cases, for example).
- If the product was sold at public auction or if the product has suffered damage as a result of force majeure: flood, fire, earthquake, storm.

This warranty is non-transferable. No new warranty period commences if the product is repaired or replaced. Your statutory rights towards the seller are not affected or restricted by this warranty. Motion Systems, and their partners are not liable for any indirect, incidental, or punitive damages from use of this product. In case of malfunction during the warranty period immediately contact technical support.

10. COPYRIGHT

Qubic System is a trademark of Motion Systems. All rights reserved.

All the contents in this user manual are the intellectual property of Motion Systems. No part of this manual, including the products and software described in it, shall be modified or translated into any language without the prior written permission of Motion Systems. Specifications and information in this manual are subject to change at any time without obligation to notify any person of such revision or changes. Illustrations are not binding.

INFO

Trademark Notice - All brand names, icons, and trademarks that appeared in this manual are the sole property of their respective holders.

11. MANUFACTURER INFORMATION

Motion Systems

Miedziana 7

55-003 Nadolice Wielkie

Poland



INFO

In support queries please contact your reseller.



QUBICSYSTEM