

MOTION COCKPIT QS-V20

4^{DOF}

ARCHITECTURE

<8ms

LATENCY

1000Hz

MAXIMUM CONTROL FREQUENCY



0.88g

MAXIMUM ACCELERATION

900mm/s

MAXIMUM VELOCITY









0-100Hz

VIBRATIONS FREQUENCY RANGE

MOTION COCKPIT QS-V20

The QS-V20 is an extended 4DoF motion cockpit, designed for pro racing car simulation, dedicated to both drivers training and sim racing enthusiasts. The motion system based on world's fastest linear actuator's technology provides incredible levels of vehicle feedback to the driver. This motion platform is suitable for Rally, GT and F1 simulations, also the small footprint and lightweight design allow to fit the machine to every racing room.

KEY FEATURES

 <p>Traction loss Incredible oversteering feedback sensation</p>	 <p>Compact design Small footprint and lightweight body</p>	 <p>Easy to deploy Predefined set of motion profiles for various actuators configurations</p>	 <p>Modular and Reconfigurable Possibility to expand the system up to 8 cooperating actuators.</p>
 <p>Wide range of motion Linear actuators with stroke up to 100 mm</p>	 <p>Super silent Extremely quiet and smooth operation</p>	 <p>Low power consumption High performance devices with minimal power budget</p>	 <p>Plug&Play Ready to work in a few minutes</p>

GENERAL SPECIFICATION

	EXCURSIONS	Q-MODE 230V		PERFORMANCE MODE 230V		HEAVY DUTY MODE 230V	
		VELOCITY	ACCELERATION	VELOCITY	ACCELERATION	VELOCITY	ACCELERATION
HEAVE	- 51.8 mm, 51.6 mm - 2.039 in, 2.031 in	0.90 m/s 35.4 in/s	8.8 m/s ²	0.50 m/s 19.6 in/s	5.9 m/s ²	0.35 m/s 13.7 in/s	2.5 m/s ²
ROLL	-7.6°, 7.6°	140°/s	1500°/s ²	80°/s	1200°/s ²	60°/s	450°/s ²
PITCH	-5.5°, 5.5°	40°/s	500°/s ²	28°/s	380°/s ²	20°/s	150°/s ²
YAW	-6.1°, 6.1°	75°/s	900°/s ²	50°/s	710°/s ²	35°/s	280°/s ²

ARCHITECTURE	4 DOF with TRACTION LOSS
MAXIMUM CONTROL FREQUENCY	1000 Hz
VIBRATIONS FREQUENCY RANGE	0-100 Hz
LATENCY	<8 ms
POWER SUPPLY REQUIREMENTS	115 / 230 VAC Single Phase
CONNECTION	USB

PAYLOAD SPECIFICATION

MAX USER WEIGHT	150 kg 330.7 lb
PRODUCT WEIGHT	280 kg 617.3 lb

MAIN DIMENSIONS

TOTAL LENGTH	1716 mm 67.55 in
TOTAL WIDTH	1195 mm 47.04 in (with step)
TOTAL HEIGHT	1020 mm 40.15 in (with step)

POWER REQUIREMENTS

	Q-MODE 230V	PERFORMANCE MODE 110 / 230V	HEAVY DUTY MODE 110 / 230V
AVERAGE POWER [kVA]	1.6	0.8 / 0.9	0.5 / 0.6
PEAK POWER [kVA]	3.1	1.2 / 1.4	1.0 / 1.2
PEAK CURRENT [A]	15	11 / 7	9 / 6
AVERAGE POWER (STRESS TEST) [kW]	0.06	0.4 / 0.4	0.3 / 0.3
AVERAGE POWER (TYPICAL GAME) [kW]	0.08	0.07 / 0.08	0.07 / 0.08

SUPPORTED TECHNOLOGIES

VR HeadWay, VBS3/4 Plugin, Self Diagnostic, Self calibration

OUR SOFTWARE

Qubic Manager (free of charge) | Motion SDK - ForceSeatDI | Motion SDK ForceSeatMI | Motion Theater

GENERAL DIMENSIONS

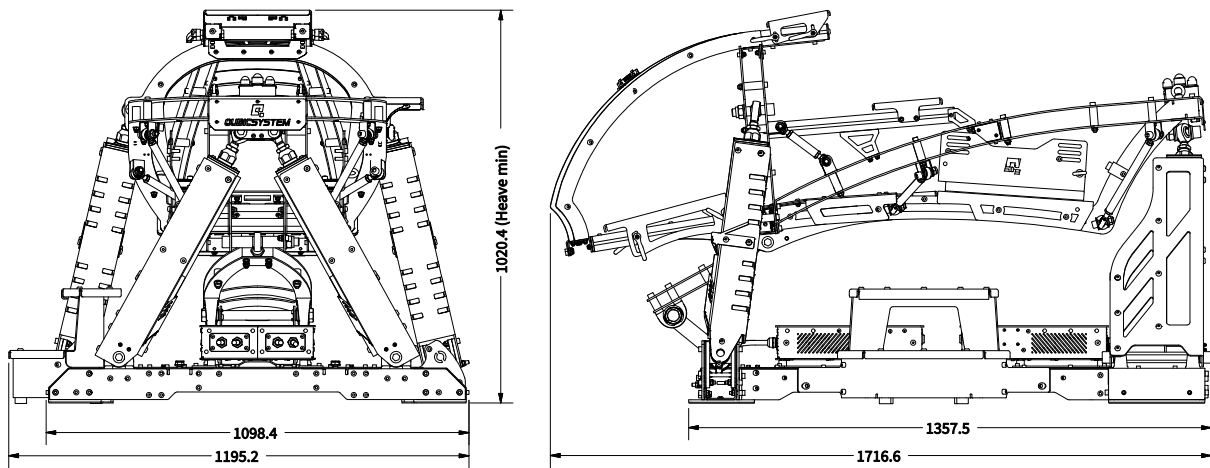

USE-CASE EXAMPLE - DRIVING SIMULATOR

